

Bornes

Línea BTW

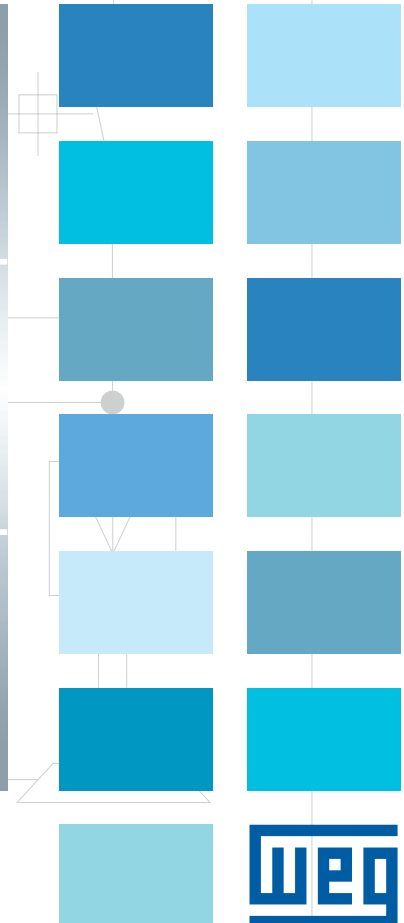
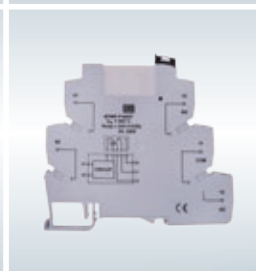
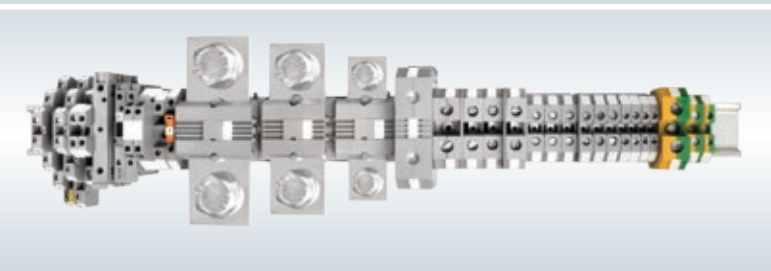
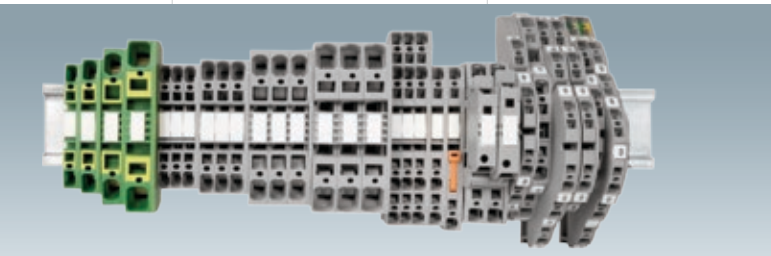
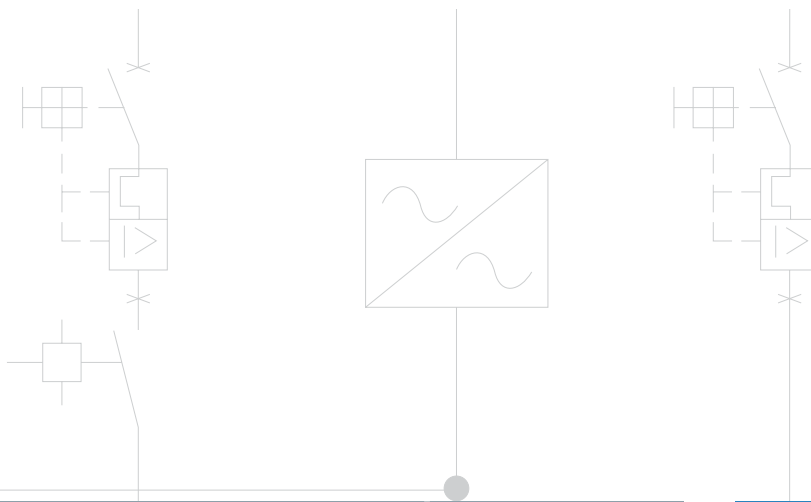

Índice - BTWP/BTWD/BTWT/BTWS/BTWA Conexión Tipo Tornillo

Bornes Terminales con Conexión Tipo Tornillo

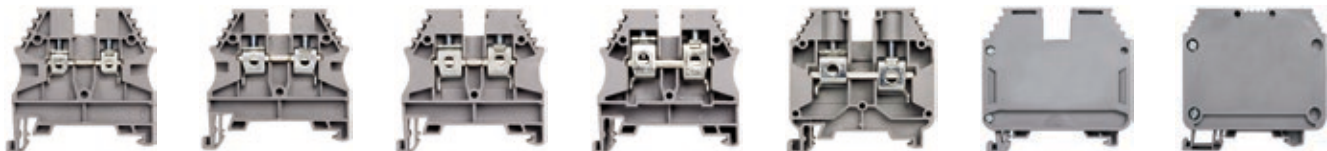

BTWP 2,5
pág 11

BTWP 4
pág 11

BTWP 6
pág 11

BTWP 10
pág 12

BTWP 16
pág 12

BTWP 35
pág 12

BTWP 70
pág 12

Bornes de Potencia



BTWP 95B
pág 13

BTWP 150B
pág 13

BTWP 240B
pág 13

Bornes Tierra



BTWP 2,5/4T
pág 14

BTWP 6/10T
pág 14

BTWP 16T
pág 14

BTWP 35T
pág 14

Bornes Doble

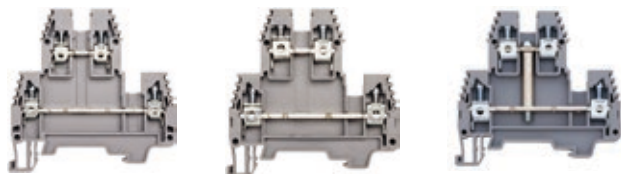

BTWD 2,5N
pág 15

BTWD 4N
pág 15

BTWD 4NK
pág 15

Borne Triple



BTWT 3
pág 15

Borne Doble + Tierra



BTWT 2T
pág 16

Borne Triple + Tierra



BTWT 3T
pág 16

Borne para Sensores

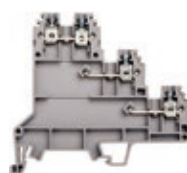

BTWT 3S
pág 16

Borne para Fusibles

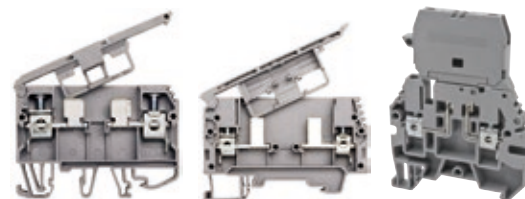

BTWS 2S
pág 17

BTWS 4S
pág 17

BTWS 3M
pág 17

Borne para Fusibles

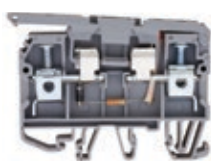

BTWS 2LD
pág 18

Borne 1In-2Out

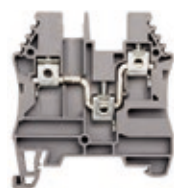

BTWP 4C
pág 18

Borne Seccionable



BTWS 3A
pág 19

Borne Seccionable /Teste



BTWA 3
pág 19

Borne Diodo



BTWD 4D
pág 19

Índice - BTWI

Conexión Tipo Resorte (Push-In)

Bornes Terminales con Conexión Tipo Resorte Autoconectable



BTWI 2,5
pág 21



BTWI 4
pág 21

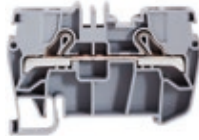

BTWI 6
pág 21

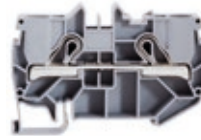

BTWI 10
pág 21

Bornes Tierra



BTWI 2,5T
pág 22



BTWI 4T
pág 22



BTWI 6T
pág 22



BTWI 10T
pág 22

Bornes Doble



BTWI 2,5-2F
pág 23



BTWI 4-2F
pág 23



BTWI 4-2FK
pág 23

Borne Triple



BTWI 2,5-3F
pág 23

Borne Doble + Tierra



BTWI 2,5-2FT
pág 24

Borne Triple + Tierra



BTWI 2,5-3FT
pág 24

Borne para Sensores



BTWI 3S
pág 24

Borne Seccionable

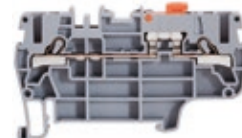

BTWI 2,5A
pág 25

Borne para Fusibles



BTWI S
pág 25



BTW SLD
pág 25



BTWI I
pág 25

Borne 1In-2Out



BTWI 2,5E
pág 26

Borne 2In-2Out



BTWI 2,5C
pág 26

Borne Tierra Doble



BTWI 2,5CT
pág 26

Índice - Línea BTWM Conexión Tipo Resorte

Bornes Terminales con Conexión Tipo Resorte



BTWM 2,5
pág 28



BTWM 4
pág 28



BTWM 6
pág 28



BTWM 10
pág 28

Bornes Tierra



BTWM 2,5T
pág 29



BTWM 4T
pág 29



BTWM 6T
pág 29



BTWM 10T
pág 29

Bornes Doble



BTWM 2,5-2F
pág 30



BTWM 4-2F
pág 30



BTWM 4-2FK
pág 30

Borne Triple



BTWM 2,5-3F
pág 30

Borne Doble + Tierra



BTWM 2,5-2FT
pág 31

Borne Triple + Tierra



BTWM 2,5-3FT
pág 31

Borne para Sensores



BTWM 3S
pág 31

Borne Seccionable

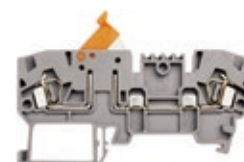

BTWM 2,5A
pág 32

Bornes para Fusibles



BTWM S
pág 32

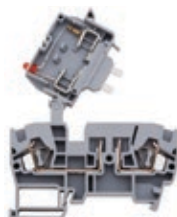

BTWM SLD
pág 32



BTWM I
pág 32

Borne 1In-2Out

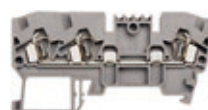

BTWM 2,5E
pág 33

Borne 2In-2Out



BTWM 2,5C
pág 33

Borne Tierra Doble



BTWM 2,5CT
pág 33

Índice - Línea BTWO

Bornes de Conexión Tipo Tornillo para Cables con Terminales Tipo Ojo y Horquilla



BTWO 6IT
pág 35



BTWO 6G
pág 35



BTWO 6I
pág 35



BTWO 6
pág 36



BTWO 10
pág 36

Índice - Línea BTWR

Relés de Interfaz



BTWR P16E26
pág 38



BTWR P16E27
pág 38



BTWR P16E28
pág 38



BTWR P16E29
pág 39



BTWR P16E31
pág 39

Índice - Línea BTWK

Mini Bornes con Terminales con Conexión Tipo Tornillo



BTWK 2,5
pág 42



BTWK 4
pág 42



BTWK 2,5T
pág 42



BTWK 4T
pág 42

Índice - Línea BTWY

Mini Bornes con Terminales con Conexión Tipo Resorte



BTWY 2,5
pág 43



BTWY 2,5P
pág 43



BTWY 2,5S
pág 43



BTWY 2,5T
pág 43

Bornes

Bornes son dispositivos que tienen función de proporcionar un medio seguro de conexión eléctrica y mecánica a los más variados conductores eléctricos. Entre todos los tipos de conectores disponibles, los bornes son los más utilizados por tener las siguientes características:

Modularidad

Todos los diversos modelos de bornes son proyectados para ser montados lado-a-lado, asegurando el mejor aprovechamiento del espacio dentro de los tableros.

Facilidad de Instalación

Su montaje en Rieles DIN es rápido y fácil, reduciendo el tiempo de montaje de los tableros.



Disponible en 5 Versiones

- Tipos de terminales:
 - Tornillo
 - Resorte (*push-in*)
 - Resorte
 - Tornillo para cable con conector tipo ojo
 - Tornillo para cable con conector tipo horquilla

Tipo Tornillo



Línea BTWP



Línea BTWR



Línea BTWK

Tipo Resorte (*Push-In*)



Línea BTWI



Tipo Resorte

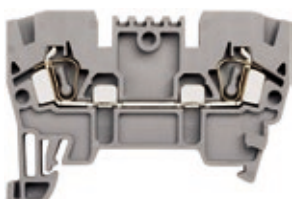

Línea BTWM



Línea BTWY

Tipo Tornillo para Cables con Conectores Tipo Ojo o Horquilla



Línea BTWO

Bornes

Amplia Línea de Accesorios

- Puentes conectoras, identificadores, riel DIN, tapa final y topes finales



PC-BTWP
PC-BTWT
PC-BTWO

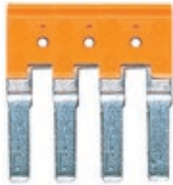

PC - BTWM/BTWI



PC-BTWO_I



PC - BTWR



Soporte del riel



Tapa final



Riel DIN



Mini riel DIN



Identificadores



PF2



PF3



PF4



PF5



STT-BTW

Topes finales



Soporte de
enclave
PF5-BTW PE

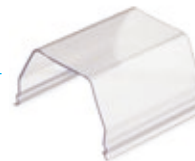
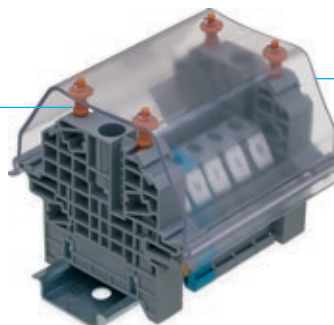

Tapa de protección
TT-BTW



Bornes

Conductores

Conductores de cobre y de aluminio son los más utilizados para a conexión de terminales, todavía los conectores de cobre son utilizados con más frecuencia.

Estos conductores son divididos en dos grupos principales:

- 1 - Hilo rígido
- 2 - Cable flexible

La sección transversal del conductor es clasificada en dos estándares: Métrico y AWG (americano).

Métrico mm ²	AWG / kcmil	Area de sección transversal AWG equivalente
0,2	24	0,205
0,34	22	0,324
0,5	20	0,519
0,75	18	0,82
1	-	-
1,5	16	1,3
2,5	14	2,1
4	12	3,3
6	10	5,3
10	8	8,4
16	6	13,3
25	4	21,2
35	2	33,6
50	0	53,5
70	00	67,4
95	000	85
-	0000	107,2
120	250 kcmil	127
150	300 kcmil	152
185	350 kcmil	177
240	500 kcmil	253
300	600 kcmil	304

AWG: (American Wire Gauge) estándar americano;

1 kcmil: 1.000 cmils;

1 cmil: (1 circular mil);

1 mil: 1/1.000 inch.

Distancias de Aislamiento y de Fuga

Los métodos de medición de las distancias de aislamiento y de fuga son especificadas de acuerdo a la norma IEC 60947-1.

Bornes WEG tienen grado de polución 3, de acuerdo con la norma IEC 60947-1.

Grado de polución	Ancho mínimo "x" en mm
1	0,25
2	1,0
3	1,5
4	2,5

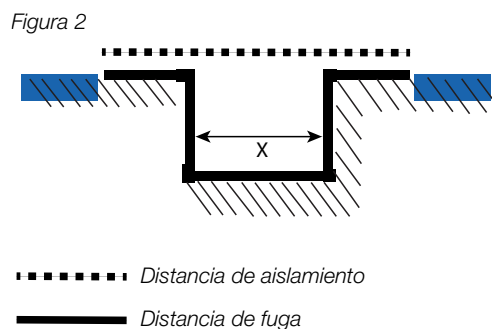
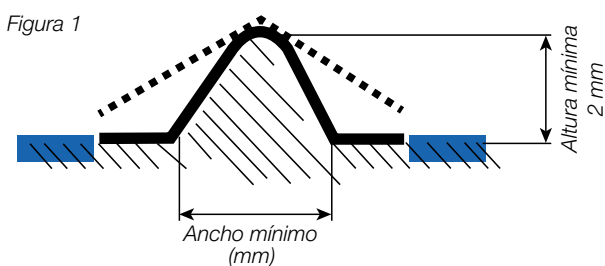

Bornes

Par de Aprietes

En terminales tipo tornillo, es muy importantes hacer los pares de apriete especificados. Si el conector tiene un par de apriete menor que el par especificado, eso podrá resultar en aumento de la resistencia y de la temperatura. Por otro lado, cuando una fuerza extrema es aplicada durante el apriete, una estructura molecular del metal podrá se destorcer y el resultado será un sobrecalentamiento. Así, si los valores nominales del par de apriete fueren aplicados de acuerdo a la norma IEC, probables riesgos de sobrecalentamiento serán eliminados.

Pares de apriete especificados en la tabla 4 de la norma IEC60947-1	Par de apriete (Nm)		
	I	II	III
Diámetros del tornillo (mm)			
Tornillos con diámetros menores que 1,6 mm	0,005	0,1	0,1
1,6 - 2	0,1	0,2	0,2
2 - 2,8	0,2	0,4	0,4
2,8 - 3	0,25	0,5	0,5
3 - 3,2	0,3	0,6	0,6
3,2 - 3,6	0,4	0,8	0,8
3,6 - 4,1	0,7	1,2	1,2
4,1 - 4,7	0,8	1,8	1,8
4,4 - 5,3	1,2	2	2
5,3 - 6	2,5	2,5	3
6 - 8	-	3,5	6
8 - 10	-	4	10
10 - 12	-	-	14
12 - 15	-	-	19
15 - 20	-	-	25
20 - 24	-	-	36
Tornillos con diámetros mayores que 24 mm	-	-	50

Columna I: aplicado para tornillos sin cabeza fijados en la cavidad de otros tornillos que no pueden ser apretados con el destornillador.

Columna II: aplicado para todos os tornillos que pueden ser apretados con destornillador.

Columna III: aplicado para tornillos y tuercas que pueden ser apretados por otras herramientas.

Ref.: IEC 60947-1 / IEC 60999-1

La WEG aplica testes para sus terminales con tornillo con el doble del par de apriete especificado en la norma IEC.

Certificaciones

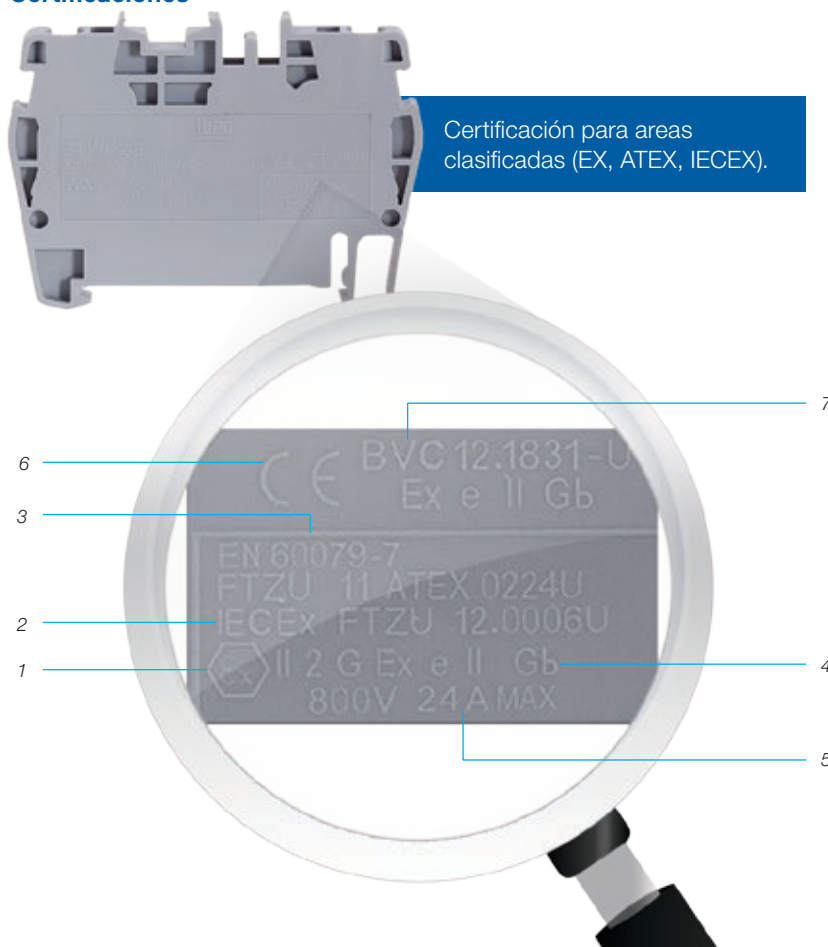

- 1 - Símbolo de protección-Ex
- 2 - Número de certificación internacional contra explosión
- 3 - Norma de referencia
- 4 - a - Grupo del equipamiento II
b - Categoría del producto 2 - para utilización en zona I y/o zona II
c - Aprobación para aplicaciones en ambiente con gas (G)
d - Clase "e" por tener mayor categoría de seguridad
- 5 - Tensión nominal y valores de corriente
- 6 - Nombre de la entidad certificadora
- 7 - Certificación BV/INMETRO

Línea BTWP - Borne Tipo Tornillo

Los bornes de la línea BTWP utilizan la técnica de conexión tipo tornillo la cual es la más popular entre todas las técnicas conocidas de conexión. Su utilización es sencilla: se remueve el aislamiento del conductor, se inserta el conductor en el bloque y aprieta el tornillo con un destornillador común. El largo del aislamiento a ser removido y el par de apriete para cada modelo de borne están indicados en las tablas de selección.

Cuando se aprieta el tornillo, la presión resultante promueve una deformación en el terminal que a su vez traba el tornillo para que no se suelte. Este sistema asegura la calidad final de conexión con mínimas pérdidas eléctricas.

Características Principales de los Bornes de la Línea BTWP

- Cuerpo del borne en poliamida PA, con excelentes propiedades dieléctricas y alta resistencia mecánica
- Elemento conductor interno de elevada capacidad de conducción de corriente
- Entrada de cables en formato cónico para facilitar la inserción
- Tornillo de los terminales imperdibles
- Certificaciones para áreas clasificadas (EX, ATEX, IECEx)









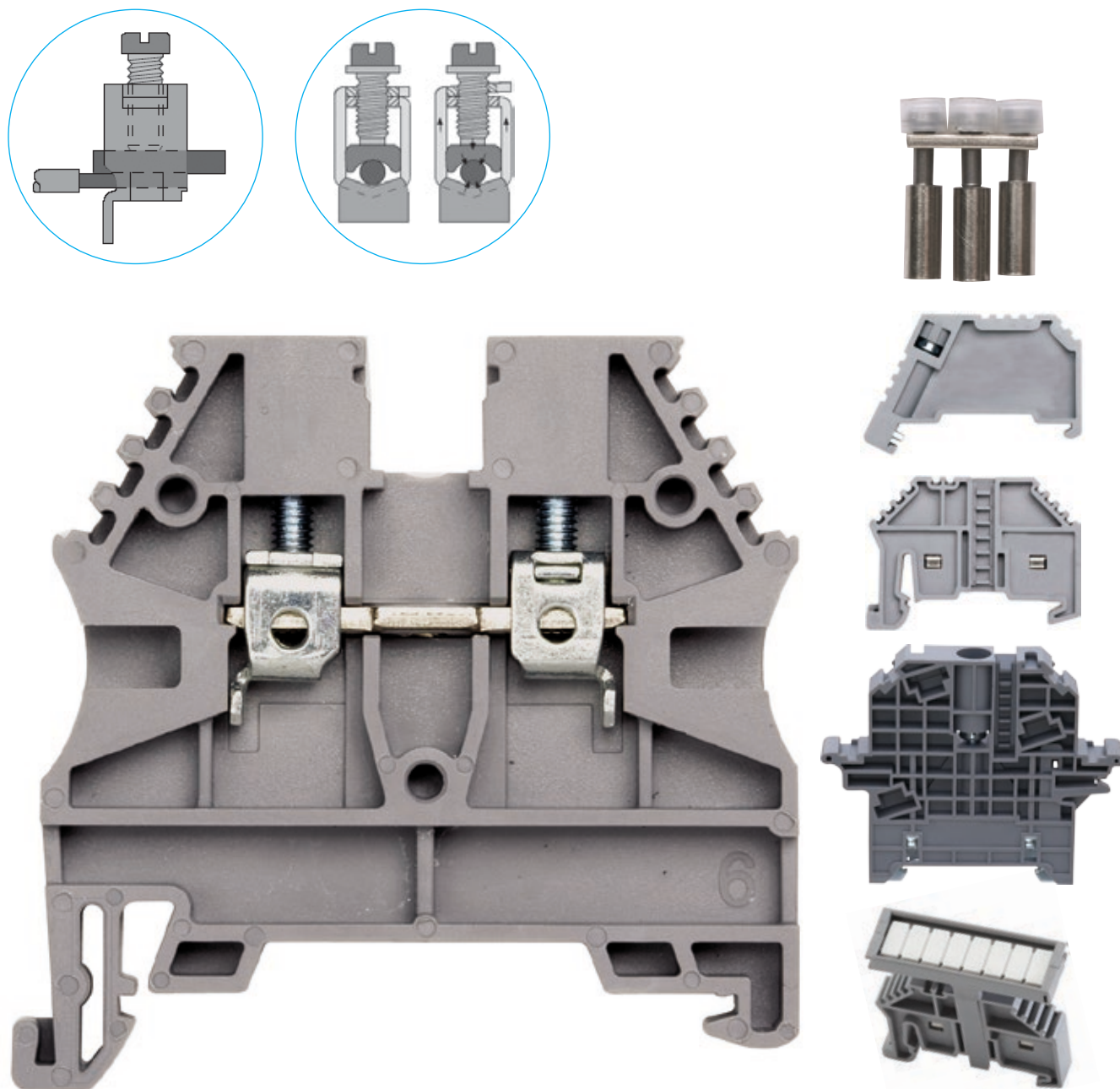

Tabla de Selección - Conexión Tipo Tornillo

Línea BTWP - Bornes Terminales con Conexión Tipo Tornillo

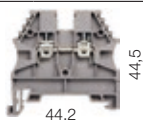
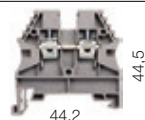
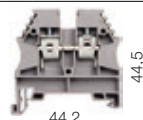
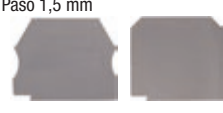

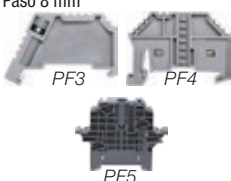

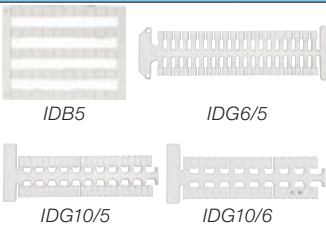







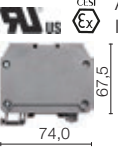









		BTWP 2,5 Paso 5 mm 		BTWP 4 Paso 6 mm 		BTWP 6 Paso 8 mm 	
							
		44,5		44,5		44,5	
		44,2		44,2		44,2	
Datos técnicos		Tensión / Corriente / Sección nominal					
IEC 60947-7-1		750 V~ / 24 A / 2,5 mm ²		750 V~ / 32 A / 4 mm ²		630 V~ / 41 A / 6 mm ²	
UL / CSA		600 V~ / 20 A / AWG 26...12		600 V~ / 30 A / AWG 26...10		600 V~ / 50 A / AWG 26...8	
Decapado del cable		10 mm		10 mm		12 mm	
Par de apriete		0,4 Nm		0,5 Nm		0,8 Nm	
Capacidad de conexión							
Hilo rígido		0,5...4 mm ²		0,5...6 mm ²		0,5...10 mm ²	
Cable flexible		1,5...2,5 mm ²		1,5...4 mm ²		1,5...6 mm ²	
Conductor AWG		26...12		26...10		26...8	
Material plástico	Color	Referencia	Cant./Embal.	Referencia	Cant./Embal.	Referencia	Cant./Embal.
	Gris	BTWP 2,5	100	BTWP 4	100	BTWP 6	100
	Azul	BTWP 2,5-AZ	100	BTWP 4-AZ	100	BTWP 6-AZ	100
	Verde	BTWP 2,5-VD	100	BTWP 4-VD	100	BTWP 6-VD	100
	Rojo	BTWP 2,5-VM	100	BTWP 4-VM	100	BTWP 6-VM	100
Tapa terminal / Placa de división	Color	Referencia	Cant./Embal.	Referencia	Cant./Embal.	Referencia	Cant./Embal.
	Gris	TF-BTWP 2,5-10	100	TF-BTWP 2,5-10	100	TF-BTWP 2,5-10	100
	Azul	TF-BTWP 2,5-10-AZ	100	TF-BTWP 2,5-10-AZ	100	TF-BTWP 2,5-10-AZ	100
	Verde	TF-BTWP 2,5-10-VD	100	TF-BTWP 2,5-10-VD	100	TF-BTWP 2,5-10-VD	100
	Gris	PD-BTWP 2,5-10	25	PD-BTWP 2,5-10	25	PD-BTWP 2,5-10	25
Placa de separación	Color	Referencia	Cant./Embal.	Referencia	Cant./Embal.	Referencia	Cant./Embal.
	Gris	PS1-BTWP	100	PS1-BTWP	100	PS1-BTWP	100
Puente conectora	Nr. polos	Referencia	Cant./Embal.	Referencia	Cant./Embal.	Referencia	Cant./Embal.
	2	PC-BTWP 2,5/2	25	PC-BTWP 4/2	25	PC-BTWP 6/2	25
	3	PC-BTWP 2,5/3	20	PC-BTWP 4/3	20	PC-BTWP 6/3	20
	4	PC-BTWP 2,5/4	15	PC-BTWP 4/4	15	PC-BTWP 6/4	15
	10	PC-BTWP 2,5/10	5	PC-BTWP 4/10	5	PC-BTWP 6/10	5
Tope final	Color	Referencia	Cant./Embal.	Referencia	Cant./Embal.	Referencia	Cant./Embal.
	Gris	PF3-BTW	100	PF3-BTW	100	PF3-BTW	100
	Gris	PF4-BTW	100	PF4-BTW	100	PF4-BTW	100
	Gris	PF5-BTW	100	PF5-BTW	100	PF5-BTW	100
Riel / Soporte	Tipo	Referencia	Cant./Embal.	Referencia	Cant./Embal.	Referencia	Cant./Embal.
	Riel	MR 35x7,5	Barras 2 m	MR 35x7,5	Barras 2 m	MR 35x7,5	Barras 2 m
	Soporte	ST-BTW	25	ST-BTW	25	ST-BTW	25
Identificador de grupo	Color	Referencia	Cant./Embal.	Referencia	Cant./Embal.	Referencia	Cant./Embal.
	Gris	IG-BTW	50	IG-BTW	50	IG-BTW	50
	Transp.	IG22-BTW ¹⁾	25	IG22-BTW ¹⁾	25	IG22-BTW ¹⁾	25
Identificador²⁾		Referencia	Cant./Embal.	Referencia	Cant./Embal.	Referencia	Cant./Embal.
		IDB5-BTW	500	IDB5-BTW	500	IDB5-BTW	500
		IDG6/5-BTW	400	IDG6/5-BTW	400	IDG6/5-BTW	400
		IDG10/5-BTW	440	IDG10/5-BTW	440	IDG10/5-BTW	440
		-		IDG10/6-BTW	360	IDG10/6-BTW	360

Notas: 1) Para montaje sobre el tope final PF4-BTW.

2) Mayores detalles de los identificadores en la página 48.

Tabla de Selección - Conexión Tipo Tornillo

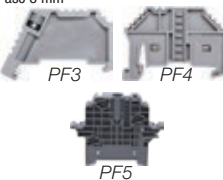
Línea BTWP - Bornes Terminales con Conexión Tipo Tornillo

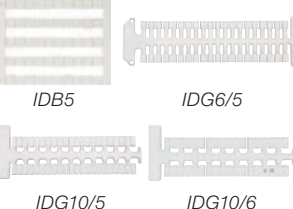







BTWP 10 Paso 10 mm		BTWP 16 Paso 12 mm		BTWP 35 Paso 16 mm		BTWP 70 Paso 22 mm				
										
CE    		CE    		CE    		CE    				
44,2		50,0		50,0		74,0				
44,5		55,5		55,5		67,5				
Datos técnicos		Tensión / Corriente / Sección nominal								
IEC 60947-7-1		630 V~ / 57 A / 10 mm ²		750 V~ / 76 A / 16 mm ²		750 V~ / 125 A / 35 mm ²		750 V~ / 192 A / 70 mm ²		
UL / CSA		600 V~ / 65 A / AWG 16...6		600 V~ / 85 A / AWG 12...4		600 V~ / 115 A / AWG 10...2		600 V~ / 175 A / AWG 6...2/0		
Decapado del cable		12 mm		16 mm		18 mm		20 mm		
Par de apriete		1,2 Nm		1,2 Nm		2,5 Nm		6 Nm		
Capacidad de conexión										
Hilo rígido		1,5...16 mm ²		1,5...16 mm ²		6...16 mm ²		10...16 mm ²		
Cable flexible		1,5...10 mm ²		1,5...16 mm ²		10...35 mm ²		10...70 mm ²		
Conductor AWG		16...6		12...4		10...2		6...2/0		
Material plástico		Color	Referencia	Cant./Embal.	Referencia	Cant./Embal.	Referencia	Cant./Embal.	Referencia	Cant./Embal.
Poliamida 66	Gris	BTWP 10	100	BTWP 16	50	BTWP 35	50	BTWP 70	10	
	Azul	BTWP 10-AZ	100	BTWP 16-AZ	50	BTWP 35-AZ	50	BTWP 70-AZ	10	
	Verde	BTWP 10-VD	100	BTWP 16-VD	50	BTWP 35-VD	50	BTWP 70-VD	10	
Tapa terminal / Placa de división		Color	Referencia	Cant./Embal.	Referencia	Cant./Embal.	Referencia	Cant./Embal.	Referencia	Cant./Embal.
Paso 1,5 mm 	Gris	TF-BTWP 2,5-10	100	TF-BTWP 16	100	PD-BTW 35 CZ				
	Azul	TF-BTWP 2,5-10-AZ	100	TF-BTWP 16-AZ	100					
	Verde	TF-BTWP 2,5-10-VD	100	TF-BTWP 16-VD	100					
	Rojo	TF-BTWP 2,5-10-VM	100	TF-BTWP 16-VM	100					
	Gris	PD-BTWP 2,5-10	25	PD-BTWP 16	25					
Placa de separación		Color	Referencia	Cant./Embal.	Referencia	Cant./Embal.	Referencia	Cant./Embal.	Referencia	Cant./Embal.
		Gris	PS1-BTWP	100	-	-	-	-	-	
Puente conectora		Nr. polos		Cant./Embal.	Referencia	Cant./Embal.	Referencia	Cant./Embal.	Referencia	Cant./Embal.
		2	PC-BTWP 10/2	25	PC-BTWP 16/2	25	PC-BTWP 35/2	25		
		3	PC-BTWP 10/3	20	PC-BTWP 16/3	20	PC-BTWP 35/3	20		
		4	PC-BTWP 10/4	15	PC-BTWP 16/4	15	PC-BTWP 35/4	15		
		10	PC-BTWP 10/10	5	PC-BTWP 16/10	5	PC-BTWP 35/10	5		
Tope final Paso 8 mm		Color	Referencia	Cant./Embal.	Referencia	Cant./Embal.	Referencia	Cant./Embal.	Referencia	Cant./Embal.
		Gris	PF3-BTW	100	PF3-BTW	100	PF3-BTW	100	PF3-BTW	100
		Gris	PF4-BTW	100	PF4-BTW	100	PF4-BTW	100	PF4-BTW	100
		Gris	PF5-BTW	100	PF5-BTW	100	PF5-BTW	100	PF5-BTW	100
Riel / Soporte DIN EN 50022		Tipo	Referencia	Cant./Embal.	Referencia	Cant./Embal.	Referencia	Cant./Embal.	Referencia	Cant./Embal.
		Riel	MR 35x7,5	Barras 2 m	MR 35x7,5	Barras 2 m	MR 35x7,5	Barras 2 m	MR 35x7,5	Barras 2 m
		Soporte	ST-BTW	25	ST-BTW	25	ST-BTW	25	ST-BTW	25
Identificador de grupo		Color	Referencia	Cant./Embal.	Referencia	Cant./Embal.	Referencia	Cant./Embal.	Referencia	Cant./Embal.
		Gris	IG-BTW	50	IG-BTW	50	IG-BTW	50	IG-BTW	50
		Transp.	IG22-BTW ¹⁾	25	IG22-BTW ¹⁾	25	IG22-BTW ¹⁾	25	IG22-BTW ¹⁾	25
Identificador ²⁾			Referencia	Cant./Embal.	Referencia	Cant./Embal.	Referencia	Cant./Embal.	Referencia	Cant./Embal.
			IDB5-BTW	500	IDB5-BTW	500	IDB5-BTW	500	IDB5-BTW	500
			IDG6/5-BTW	400	IDG6/5-BTW	400	IDG6/5-BTW	400	IDG6/5-BTW	400
			IDG10/5-BTW	440	IDG10/5-BTW	440	IDG10/5-BTW	440	IDG10/5-BTW	440
			IDG10/6-BTW	360	IDG10/6-BTW	360	IDG10/6-BTW	360	IDG10/6-BTW	360

Notas: 1) Para montaje sobre el tope final PF4-BTW.

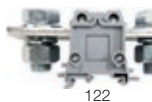
2) Mayores detalles de los identificadores en la página 48.

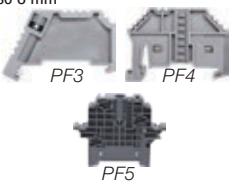
Tabla de Selección - Conexión Tipo Tornillo

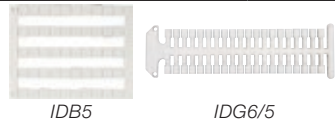
Línea BTWP - Bornes de Potencia

		BTWP 95B Paso 40 mm 	BTWP 150B Paso 48 mm 	BTWP 240B Paso 53 mm 			
Datos técnicos		Tensión / Corriente / Sección nominal					
IEC 60947-7-1		1.000 V~ / 232 A / 95 mm ²	1.000 V~ / 309 A / 150 mm ²	1.000 V~ / 415 A / 240 mm ²			
Tornillo		M10x30	M12x30	M16x35			
Par de apriete		6 Nm	8 Nm	10 Nm			
Material plástico	Color	Referencia	Cant./Embal.	Referencia	Cant./Embal.	Referencia	Cant./Embal.
Poliamida 66	Gris	BTWP 95B	4	BTWP 150B	4	BTWP 240B	4
Tapa de aislamiento	Color	Referencia	Cant./Embal.	Referencia	Cant./Embal.	Referencia	Cant./Embal.
	Gris	TI-BTWP 95	4	TI-BTWP 150	4	TI-BTWP 240	4
Tope final	Color	Referencia	Cant./Embal.	Referencia	Cant./Embal.	Referencia	Cant./Embal.
Paso 8 mm 	Gris	PF3-BTW	100	PF3-BTW	100	PF3-BTW	100
	Gris	PF4-BTW	100	PF4-BTW	100	PF4-BTW	100
	Gris	PF5-BTW	100	PF5-BTW	100	PF5-BTW	100
Riel / Soporte	Tipo	Referencia	Cant./Embal.	Referencia	Cant./Embal.	Referencia	Cant./Embal.
DIN EN 50022 	Riel	MR 35x7,5	Barras 2 m	MR 35x7,5	Barras 2 m	MR 35x7,5	Barras 2 m
	Soporte	ST-BTW	25	ST-BTW	25	ST-BTW	25
Identificador de grupo	Color	Referencia	Cant./Embal.	Referencia	Cant./Embal.	Referencia	Cant./Embal.
	Gris	IG-BTW	50	IG-BTW	50	IG-BTW	50
	Transp.	IG22-BTW ¹⁾	25	IG22-BTW ¹⁾	25	IG22-BTW ¹⁾	25
Identificador²⁾		Referencia	Cant./Embal.	Referencia	Cant./Embal.	Referencia	Cant./Embal.
		IDB5-BTW	500	IDB5-BTW	500	IDB5-BTW	500
		IDG6/5-BTW	400	IDG6/5-BTW	400	IDG6/5-BTW	400
		IDG10/5-BTW	440	IDG10/5-BTW	440	IDG10/5-BTW	440
		IDG10/6-BTW	360	IDG10/6-BTW	360	IDG10/6-BTW	360



Notas: 1) Para montaje sobre el tope final PF4-BTW.

2) Mayores detalles de los identificadores en la página 48.

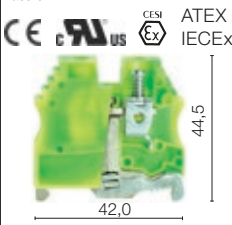
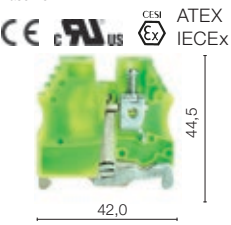
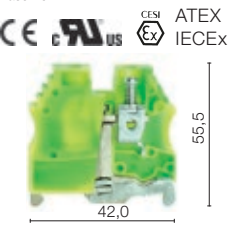
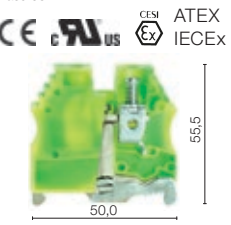
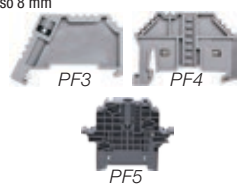

Tabla de Selección - Conexión Tipo Tornillo

Línea BTWP - Bornes Tierra

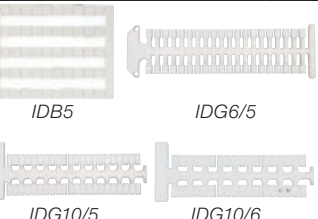
		BTWP 2,5/4T Paso 6 mm	BTWP 6/10T Paso 10 mm	BTWP 16T Paso 16 mm	BTWP 35T Paso 35 mm				
									
Datos técnicos		Sección nominal							
IEC 60947-7-1		4 mm ²	10 mm ²	16 mm ²	35 mm ²				
UL / CSA		AWG 26...10	AWG 16...8	AWG 12...4	AWG 12...2				
Decapado del cable		10 mm	12 mm	18 mm	18 mm				
Par de apriete		0,5 Nm	1,2 Nm	2,5 Nm	2,5 Nm				
Capacidad de conexión									
Hilo rígido		0,5...6 mm ²	1,5...16 mm ²	6...16 mm ²	6...16 mm ²				
Cable flexible		1,5...4 mm ²	1,5...10 mm ²	10...35 mm ²	10...35 mm ²				
Conductor AWG		26...10	16...8	10...2	10...2				
Material plástico	Color	Referencia	Cant./Embal.	Referencia	Cant./Embal.	Referencia	Cant./Embal.	Referencia	Cant./Embal.
Poliamida 66	Verde/ amarillo	BTWP 2,5/4T-VD/AM	50	BTWP 6/10T-VD/AM	25	BTWP 16/35T-VD/AM	25	BTWP 16/35T-VD/AM	25
Tope final	Color	Referencia	Cant./Embal.	Referencia	Cant./Embal.	Referencia	Cant./Embal.	Referencia	Cant./Embal.
Paso 8 mm									
	Gris	PF3-BTW	100	PF3-BTW	100	PF3-BTW	100	PF3-BTW	100
	Gris	PF4-BTW	100	PF4-BTW	100	PF4-BTW	100	PF4-BTW	100
	Gris	PF5-BTW	100	PF5-BTW	100	PF5-BTW	100	PF5-BTW	100
Riel / Soporte	Tipo	Referencia	Cant./Embal.	Referencia	Cant./Embal.	Referencia	Cant./Embal.	Referencia	Cant./Embal.
DIN EN 50022									
	Riel	MR 35x7,5	Barras 2 m	MR 35x7,5	Barras 2 m	MR 35x7,5	Barras 2 m	MR 35x7,5m	Barras 2 m
	Soporte	ST-BTW	25	ST-BTW	25	ST-BTW	25	ST-BTW	25
Identificador de grupo	Color	Referencia	Cant./Embal.	Referencia	Cant./Embal.	Referencia	Cant./Embal.	Referencia	Cant./Embal.
	Gris	IG-BTW	50	IG-BTW	50	IG-BTW	50	IG-BTW	50
	Transp.	IG22-BTW ¹⁾	25	IG22-BTW ¹⁾	25	IG22-BTW ¹⁾	25	IG22-BTW ¹⁾	25
Identificador²⁾		Referencia	Cant./Embal.	Referencia	Cant./Embal.	Referencia	Cant./Embal.	Referencia	Cant./Embal.
		IDB5-BTW	500	IDB5-BTW	500	IDB5-BTW	500	IDB5-BTW	500
		IDG6/5-BTW	400	IDG6/5-BTW	400	IDG6/5-BTW	400	IDG6/5-BTW	400
		IDG10/5-BTW	440	IDG10/5-BTW	440	IDG10/5-BTW	440	IDG10/5-BTW	440
		IDG10/6-BTW	360	IDG10/6-BTW	360	IDG10/6-BTW	360	IDG10/6-BTW	360







Notas: 1) Para montaje sobre el tope final PF4-BTW.

2) Mayores detalles de los identificadores en la página 48.

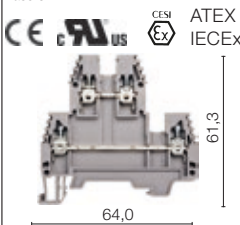
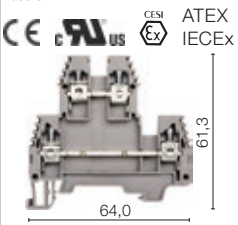
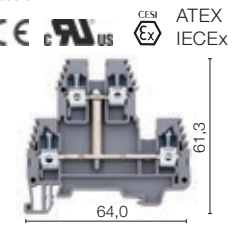
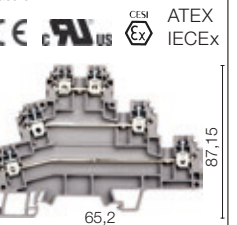

Tabla de Selección - Conexión Tipo Tornillo

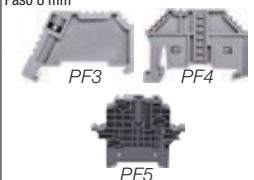
Línea BTWD / BTWT - Borne Doble y Borne Triple

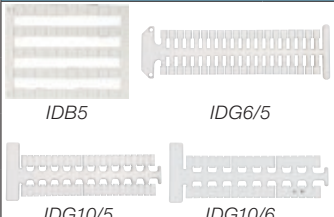
		BTWD 2,5N Paso 5 mm 	BTWD 4N Paso 6 mm 	BTWD 4NK Paso 6 mm 	BTWT 3 Paso 6 mm 				
Datos técnicos									
		Tensión / Corriente / Sección nominal							
IEC 60947-7-1		500 V~ / 24 A / 2,5 mm ²		500 V~ / 32 A / 4 mm ²		500 V~ / 32 A / 4 mm ²		440 V~ / 24 A / 2,5 mm ²	
UL / CSA		300 V~ / 20 A / AWG 26...12		300 V~ / 30 A / AWG 26...10		300 V~ / 30 A / AWG 26...10		300 V~ / 24 A / AWG 24...12	
Decapado del cable		9 mm		9 mm		9 mm		9 mm	
Par de apriete		0,4 Nm		0,5 Nm		0,5 Nm		0,4 Nm	
Capacidad de conexión		Capacidad de conexión							
Hilo rígido		0,5...4 mm ²		0,5...6 mm ²		0,5...6 mm ²		0,5...4 mm ²	
Cable flexible		1,5...2,5 mm ²		1,5...4 mm ²		1,5...4 mm ²		1,5...2,5 mm ²	
Conductor AWG		26...12		26...10		26...10		24...12	
Material plástico	Color	Referencia	Cant./Embal.	Referencia	Cant./Embal.	Referencia	Cant./Embal.	Referencia	Cant./Embal.
Poliamida 66	Gris	BTWD 2,5N	100	BTWD 4N	100	BTWD 4N	20	BTWT 3	25
Tapa terminal	Color	Referencia	Cant./Embal.	Referencia	Cant./Embal.	Referencia	Cant./Embal.	Referencia	Cant./Embal.
Paso 1,5 mm 	Gris	TF-BTWD 2,5-4N	25	TF-BTWD 2,5-4N	25	TF-BTWD 2,5-4N	25	TF-BTWT 3	10
Placa de separación	Color	Referencia	Cant./Embal.	Referencia	Cant./Embal.	Referencia	Cant./Embal.	Referencia	Cant./Embal.
	Gris	-	-	-	-	-	-	PS1-BTWP	100
Puente conectora	Nr. polos	Referencia	Cant./Embal.	Referencia	Cant./Embal.	Referencia	Cant./Embal.	Referencia	Cant./Embal.
	2	PC-BTWP 2,5/2	25	PC-BTWP 4/2	25	PC-BTWP 2,5/2	25	PC-BTWT 2,5/2	25
	3	PC-BTWP 2,5/3	20	PC-BTWP 4/3	20	PC-BTWP 2,5/3	20	PC-BTWT 2,5/3	20
	4	PC-BTWP 2,5/4	15	PC-BTWP 4/4	15	PC-BTWP 2,5/4	15	PC-BTWT 2,5/4	15
	10	PC-BTWP 2,5/10	5	PC-BTWP 4/10	5	PC-BTWP 2,5/10	5	PC-BTWT 2,5/10	5
Tope final	Color	Referencia	Cant./Embal.	Referencia	Cant./Embal.	Referencia	Cant./Embal.	Referencia	Cant./Embal.
Paso 8 mm 	Gris	PF3-BTW	100	PF3-BTW	100	PF3-BTW	100	PF3-BTW	100
	Gris	PF4-BTW	100	PF4-BTW	100	PF4-BTW	100	PF4-BTW	100
	Gris	PF5-BTW	100	PF5-BTW	100	PF5-BTW	100	PF5-BTW	100
Riel / Soporte	Tipo	Referencia	Cant./Embal.	Referencia	Cant./Embal.	Referencia	Cant./Embal.	Referencia	Cant./Embal.
DIN EN 50022 	Riel	MR 35x7,5	Barras 2 m	MR 35x7,5	Barras 2 m	MR 35x7,5	Barras 2 m	MR 35x7,5	Barras 2 m
	Soporte	ST-BTW	25	ST-BTW	25	ST-BTW	25	ST-BTW	25
Identificador de grupo	Color	Referencia	Cant./Embal.	Referencia	Cant./Embal.	Referencia	Cant./Embal.	Referencia	Cant./Embal.
	Gris	IG-BTW	50	IG-BTW	50	IG-BTW	50	IG-BTW	50
	Transp.	IG22-BTW ¹⁾	25	IG22-BTW ¹⁾	25	IG22-BTW ¹⁾	25	IG22-BTW ¹⁾	25
Identificador²⁾		Referencia	Cant./Embal.	Referencia	Cant./Embal.	Referencia	Cant./Embal.	Referencia	Cant./Embal.
		IDB5-BTW	500	IDB5-BTW	500	IDB5-BTW	500	IDB5-BTW	500
		IDG6/5-BTW	400	IDG6/5-BTW	400	IDG6/5-BTW	400	-	-
		IDG10/5-BTW	440	IDG10/5-BTW	440	IDG10/5-BTW	440	-	-
		-	-	IDG10/6-BTW	360	IDG10/6-BTW	360	-	-

Notas: 1) Para montaje sobre el tope final PF4-BTW.
2) Mayores detalles de los identificadores en la página 48.

Tabla de Selección - Conexión Tipo Tornillo

Línea BTWT - Borne Doble + Tierra - Borne Triple + Tierra - Borne para Sensores

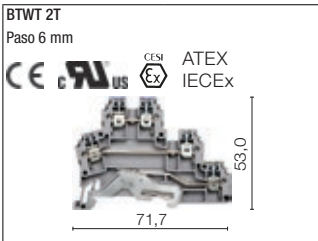
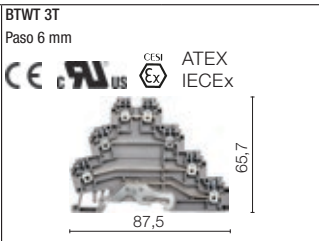
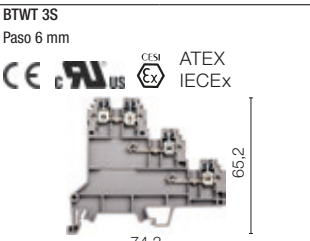
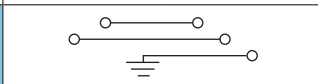
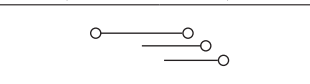







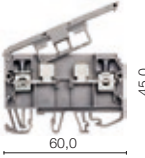

		BTWT 2T Paso 6 mm		BTWT 3T Paso 6 mm		BTWT 3S Paso 6 mm	
							
Datos técnicos							
		Tensión / Corriente / Sección nominal					
IEC 60947-7-1		440 V~ / 24 A / 2,5 mm ²		440 V~ / 24 A / 2,5 mm ²		500 V~ / 24 A / 2,5 mm ²	
UL / CSA		300 V~ / 24 A / AWG 24...12		300 V~ / 24 A / AWG 24...12		300 V~ / 20 A / AWG 24...12	
Decapado del cable		9 mm		9 mm		9 mm	
Par de apriete		0,4 Nm		0,4 Nm		0,4 Nm	
Capacidad de conexión							
Hilo rígido		0,5...4 mm ²		0,5...4 mm ²		0,5...4 mm ²	
Cable flexible		1,5...2,5 mm ²		1,5...2,5 mm ²		1,5...2,5 mm ²	
Conductor AWG		24...12		24...12		24...12	
Material plástico	Color	Referencia	Cant./Embal.	Referencia	Cant./Embal.	Referencia	Cant./Embal.
Poliamida 66	Gris	BTWT 2T	25	BTWT 3T	25	BTWT 3S	20
Tapa terminal / Placa de división	Color	Referencia	Cant./Embal.	Referencia	Cant./Embal.	Referencia	Cant./Embal.
Paso 1,5 mm	Gris	TF-BTWT 2T	10	TF-BTWT 3T	10	TF-BTWT 3S	10
Placa de separación	Color	Referencia	Cant./Embal.	Referencia	Cant./Embal.	Referencia	Cant./Embal.
	Gris	PS1-BTWP	100	PS1-BTWP	100	PS1-BTWP	100
Puente conectora	Nr. polos	Referencia	Cant./Embal.	Referencia	Cant./Embal.	Referencia	Cant./Embal.
	2	PC-BTWT 2,5/2	25	PC-BTWT 2,5/2	25	PC-BTWT 2,5/2	25
	3	PC-BTWT 2,5/3	20	PC-BTWT 2,5/3	20	PC-BTWT 2,5/3	20
	4	PC-BTWT 2,5/4	15	PC-BTWT 2,5/4	15	PC-BTWT 2,5/4	15
	10	PC-BTWT 2,5/10	5	PC-BTWT 2,5/10	5	PC-BTWT 2,5/10	5
Tope final	Color	Referencia	Cant./Embal.	Referencia	Cant./Embal.	Referencia	Cant./Embal.
Paso 8 mm	Gris	PF3-BTW	100	PF3-BTW	100	PF3-BTW	100
	Gris	PF4-BTW	100	PF4-BTW	100	PF4-BTW	100
	Gris	PF5-BTW	100	PF5-BTW	100	PF5-BTW	100
Riel / Soporte	Tipo	Referencia	Cant./Embal.	Referencia	Cant./Embal.	Referencia	Cant./Embal.
DIN EN 50022	Riel	MR 35x7,5	Barras 2 m	MR 35x7,5	Barras 2 m	MR 35x7,5	Barras 2 m
	Soporte	ST-BTW	25	ST-BTW	25	ST-BTW	25
Identificador de grupo	Color	Referencia	Cant./Embal.	Referencia	Cant./Embal.	Referencia	Cant./Embal.
	Gris	IG-BTW	50	IG-BTW	50	IG-BTW	50
	Transp.	IG22-BTW ¹⁾	25	IG22-BTW ¹⁾	25	IG22-BTW ¹⁾	25
Identificador²⁾		Referencia	Cant./Embal.	Referencia	Cant./Embal.	Referencia	Cant./Embal.
		IDB5	500	IDB5-BTW	500	IDB5-BTW	500
		IDG6/5		IDB5-BTW		IDB5-BTW	
		IDG10/5		IDB5-BTW		IDB5-BTW	
		IDG10/6		IDB5-BTW		IDB5-BTW	

Notas: 1) Para montaje sobre el tope final PF4-BTW.

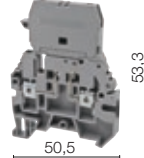
2) Mayores detalles de los identificadores en la página 48.

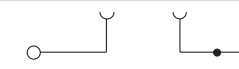
Tabla de Selección - Conexión Tipo Tornillo

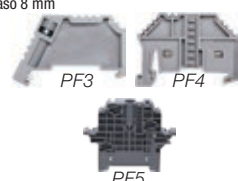

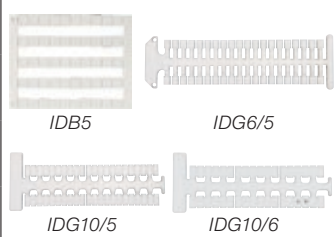





Línea BTWS - Bornes para Fusibles

	BTWS 2S Paso 8 mm 	BTWS 4S Paso 10 mm 	BTWS 3M Paso 6 mm 				
							
Datos técnicos							
	Tensión / Corriente / Sección nominal						
IEC 60947-7-1	500 V~ / 6,3 A / 6 mm ²	750 V~ / 6,3 A / 6 mm ²	750 V~ / 6,3 A / 4 mm ²				
UL / CSA	300 V~ / 6,3 A / AWG 26...8	600 V~ / 6,3 A / AWG 22...8	600 V~ / 6,3 A / AWG 22...8				
Dimensiones del fusible	5x20 o 5x25 mm	6,35x31,75 mm (1/4"x1 1/4")	5x20 o 5x25 mm				
Decapado del cable	12 mm	12 mm	12 mm				
Par de apriete	0,8 Nm	0,8 Nm	0,8 Nm				
Capacidad de conexión							
Hilo rígido	0,5...10 mm ²	0,5...10 mm ²	0,5...6 mm ²				
Cable flexible	1,5...6 mm ²	1,5...6 mm ²	1,5...4 mm ²				
Conductor AWG	26...8	22...8	22...8				
Material plástico	Color	Referencia	Cant./Embal.	Referencia	Cant./Embal.	Referencia	Cant./Embal.
Poliáamida 66	Gris	BTWS 2S	50	BTWS 4S	20	BTWS 3M	20
		Nota: acomoda un fusible de repuesto dentro del eje basculante.		Nota: acomoda un fusible de repuesto dentro del eje basculante.			
Tapa terminal	Color	Referencia	Cant./Embal.	Referencia	Cant./Embal.	Referencia	Cant./Embal.
Paso 1,5 mm 	Gris	TF-BTWS 2	10	Suministrado con tapa final		TF-BTWS 3	10
Tope final	Color	Referencia	Cant./Embal.	Referencia	Cant./Embal.	Referencia	Cant./Embal.
Paso 8 mm 	Gris	PF3-BTW	100	PF3-BTW	100	PF3-BTW	100
	Gris	PF4-BTW	100	PF4-BTW	100	PF4-BTW	100
	Gris	PF5-BTW	100	PF5-BTW	100	PF5-BTW	100
Riel / Soporte	Tipo	Referencia	Cant./Embal.	Referencia	Cant./Embal.	Referencia	Cant./Embal.
DIN EN 50022 	Riel	MR 35x7,5	Barras 2 m	MR 35x7,5	Barras 2 m	MR 35x7,5	Barras 2 m
	Soporte	ST-BTW	25	ST-BTW	25	ST-BTW	25
Identificador de grupo	Color	Referencia	Cant./Embal.	Referencia	Cant./Embal.	Referencia	Cant./Embal.
	Gris	IG-BTW	50	IG-BTW	50	IG-BTW	50
	Transp.	IG22-BTW ¹⁾	25	IG22-BTW ¹⁾	25	IG22-BTW ¹⁾	25
Identificador ²⁾		Referencia	Cant./Embal.	Referencia	Cant./Embal.	Referencia	Cant./Embal.
		IDB5-BTW	500	IDB5-BTW	500	IDB5-BTW	500
		-		IDG6/5-BTW	400	IDG6/5-BTW	400
		-		IDG10/5-BTW	440	IDG10/5-BTW	440
		-		IDG10/6-BTW	360	IDG10/6-BTW	360

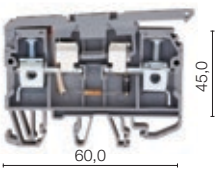
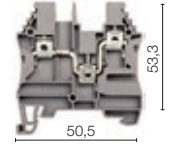
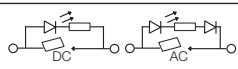
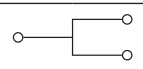
Notas: 1) Para montaje sobre el tope final PF4-BTW.
2) Mayores detalles de los identificadores en la página 48.

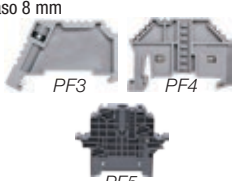
Tabla de Selección - Conexión Tipo Tornillo

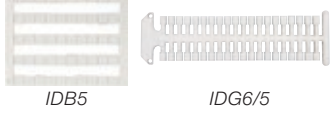
Línea BTWS - Bornes para Fusibles - Borne 1In-2Out





		BTWS 2LD Paso 8 mm 	BTWP 4C Paso 6 mm 		
					
Datos técnicos					
		Tensión / Corriente / Sección nominal			
IEC 60947-7-1		- V~ / 6,3 A / 6 mm ²	750 V~ / 32 A / 4 mm ²		
UL / CSA		- V~ / 6,3 A / AWG 26...8	600 V~ / 29 A / AWG 22...10		
Dimensiones del fusible		5x20 or 5x25 mm	-		
Decapado del cable		12 mm	10 mm		
Par de apriete		0,8 Nm	0,5 Nm		
Capacidad de conexión					
Hilo rígido		0,5...10 mm ²	0,5...6 mm ²		
Cable flexible		1,5...6 mm ²	1,5...4 mm ²		
Conductor AWG		26...8	26...10		
Material plástico	Color	Referencia	Cant./Embal.	Referencia	Cant./Embal.
Poliamida 66	Gris	BTWS 2LD C03 - 24 V cc BTWS 2LD D13 - 110 V ca BTWS 2LD D23 - 220 V ca	25	BTWP 4C	50
Tapa terminal	Color	Referencia	Cant./Embal.	Referencia	Cant./Embal.
Paso 1,5 mm 	Gris	TF-BTWS 2	10	TF-BTWP 4C	10
Tope final	Color	Referencia	Cant./Embal.	Referencia	Cant./Embal.
Paso 8 mm 	Gris	PF3-BTW	100	PF3-BTW	100
	Gris	PF4-BTW	100	PF4-BTW	100
	Gris	PF5-BTW	100	PF5-BTW	100
Riel / Soporte	Tipo	Referencia	Cant./Embal.	Referencia	Cant./Embal.
DIN EN 50022 	Riel	MR 35x7,5	Barras 2 m	MR 35x7,5	Barras 2 m
	Soporte	ST-BTW	25	ST-BTW	25
Identificador de grupo	Color	Referencia	Cant./Embal.	Referencia	Cant./Embal.
	Gris	IG-BTW	50	IG-BTW	50
	Transp.	IG22-BTW ¹⁾	25	IG22-BTW ¹⁾	25
Identificador²⁾		Referencia	Cant./Embal.	Referencia	Cant./Embal.
		IDB5-BTW	500	IDB5-BTW	500
		IDG6/5-BTW	400	IDG6/5-BTW	400
		IDG10/5-BTW	440	IDG10/5-BTW	440
		IDG10/6-BTW	360	IDG10/6-BTW	360

Notas: 1) Para montaje sobre el tope final PF4-BTW.

2) Mayores detalles de los identificadores en la página 48.

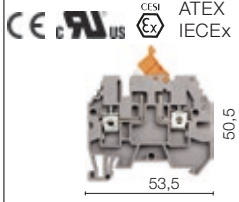
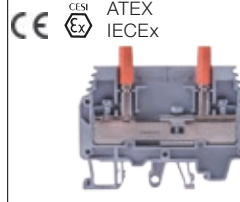
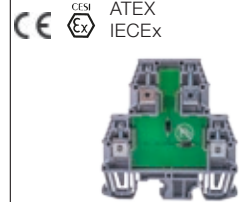
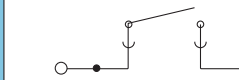
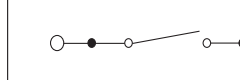
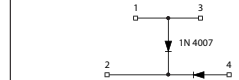
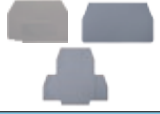
Tabla de Selección - Conexión Tipo Tornillo

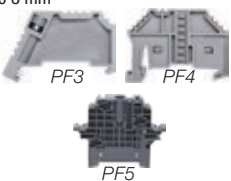
Línea BTWS / BTWA / BTWD - Borne Seccionable - Borne de Medición Seccionable - Borne Diodo

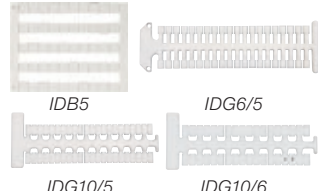
		BTWS 3A - Seccionable Paso 6 mm 		BTWA 3 - Medición Seccionable Paso 8 mm 		BTWD 4D Paso 8 mm 	
							
Datos técnicos		Tensión / Corriente / Sección nominal					
IEC 60947-7-1		500 V~ / 16 A / 4 mm ²		400 V / 41 A / 6 mm ²		1.000 V / 10 A / 6 mm ²	
UL / CSA		600 V~ / 16 A / AWG 26...10		-		-	
Decapado del cable		10 mm		10 mm		10 mm	
Par de apriete		0,5 Nm		1,5 Nm		1,5 Nm	
Capacidad de conexión							
Hilo rígido		0,5...6 mm ²		1,5 - 6 mm ²		0,5 - 6 mm ²	
Cable flexible		1,5...4 mm ²		1,5 - 6 mm ²		0,5 - 2,5 mm ²	
Conductor AWG		26...10		16...8		22...12	
Material plástico	Color	Referencia	Cant./Embal.	Referencia	Cant./Embal.	Referencia	Cant./Embal.
Poliamida 66	Gris	BTWS 3A	20	BTWA 3	50	BTWD 4D	50
Tapa terminal / Placa de división	Color	Referencia	Cant./Embal.	Referencia	Cant./Embal.	Referencia	Cant./Embal.
Paso 1,5 mm 	Gris	TF-BTWS 3	10	TF-BTWA 10/1A	25	TF-BTWD 4D 2,5-4	25
Placa de separación	Color	Referencia	Cant./Embal.	Referencia	Cant./Embal.	Referencia	Cant./Embal.
	Gris	PS1-BTWP	100	PS1-BTWP	100	PS1-BTWP	100
Puente conectora	Nr. polos	Referencia	Cant./Embal.	Referencia	Cant./Embal.	Referencia	Cant./Embal.
	2	-	-	PC-BTWA 6/2	25	-	-
	3			PC-BTWA 6/3	20		
	4			PC-BTWA 6/4	15		
	10			PC-BTWA 6/10	5		
Tope final	Color	Referencia	Cant./Embal.	Referencia	Cant./Embal.	Referencia	Cant./Embal.
Paso 8 mm 	Gris	PF3-BTW	100	PF3-BTW	100	PF3-BTW	100
	Gris	PF4-BTW	100	PF4-BTW	100	PF4-BTW	100
	Gris	PF5-BTW	100	PF5-BTW	100	PF5-BTW	100
Riel / Soporte	Tipo	Referencia	Cant./Embal.	Referencia	Cant./Embal.	Referencia	Cant./Embal.
DIN EN 50022 	Riel	MR 35x7,5	Barras 2 m	MR 35x7,5	Barras 2 m	MR 35x7,5	Barras 2 m
	Soporte	ST-BTW	25	ST-BTW	25	ST-BTW	25
Identificador de grupo	Color	Referencia	Cant./Embal.	Referencia	Cant./Embal.	Referencia	Cant./Embal.
	Gris	IG-BTW	50	IG-BTW	50	IG-BTW	50
	Transp.	IG22-BTW ¹⁾	25	IG22-BTW ¹⁾	25	IG22-BTW ¹⁾	25
Identificador ²⁾		Referencia	Cant./Embal.	Referencia	Cant./Embal.	Referencia	Cant./Embal.
		IDB5-BTW	500	-	-	IDB5-BTW	500
		IDG6/5-BTW	400	IDG6/5-BTW	400	-	-
		IDG10/5-BTW	440	IDG10/5-BTW	440	-	-
		IDG10/6-BTW	360	IDG10/6-BTW	360	-	-

Notas: 1) Para montaje sobre el tope final PF4-BTW.
2) Mayores detalles de los identificadores en la página 48.

Línea BTWI - Conexión Tipo Resorte (*Push-In*)

Los bornes de la línea BTWI permiten la conexión directa, sin la utilización de herramientas, de cables flexibles con terminal prensado o hilos rígidos decapados.

El formato especial del resorte del terminal permite el enclave seguro de los conductores. El resorte de contacto es abierto automáticamente durante la inserción del conductor y garantiza la fuerza necesaria para prensar el conductor contra la barra conductora de corriente. La estructura del cuerpo del resorte garantiza también el trabamiento progresivo y anti vibración del conductor. La abertura del resorte para liberación del conductor es hecha a través de un destornillador.

Principales Ventajas de los Bornes de la Línea BTWI

- Conexión segura y confiable
- No necesita de herramientas para conexión
- Economía de tiempo de montaje
- Completa línea de accesorios
- Sistema anti vibración
- Certificaciones CE, UL, ATEX y ICEX











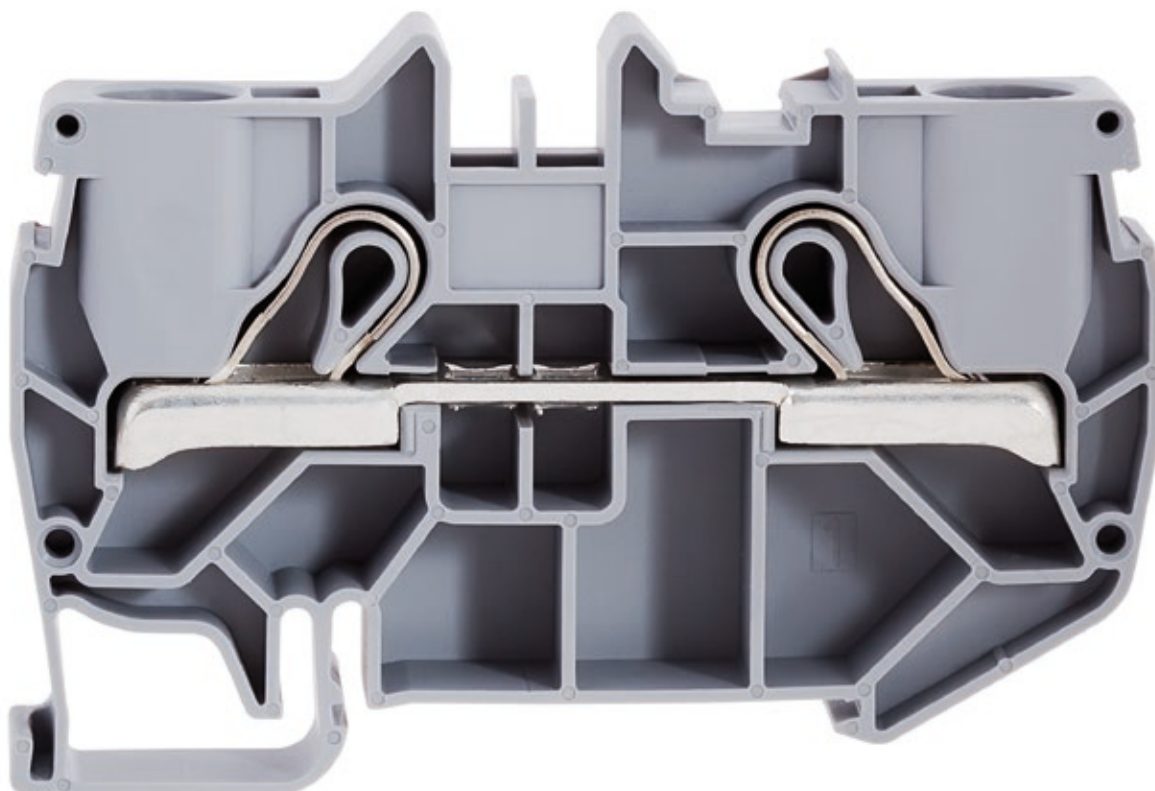
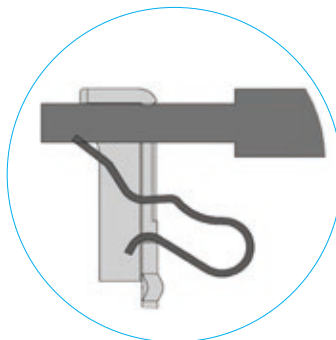
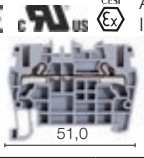

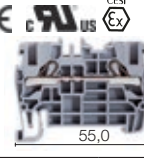
Tabla de Selección - Conexión Tipo Resorte (*Push-In*)

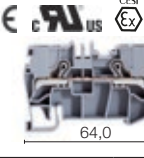
Línea BTWI - Bornes Terminales con Contacto tipo Resorte Autoconectable

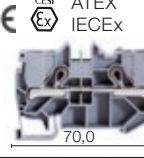
		BTWI 2,5 Paso 5 mm  CE C _{RU} US  ATEX IECEx 35,5 51,0		BTWI 4 Paso 6 mm  CE C _{RU} US  ATEX IECEx 37,0 55,0		BTWI 6 Paso 8 mm  CE C _{RU} US  ATEX IECEx 38,5 64,0		BTWI 10 Paso 10 mm  CE  ATEX IECEx 43,0 70,0	
Datos técnicos		Tensión / Corriente / Sección nominal							
IEC 60947-7-1		750 V~ / 24 A / 2,5 mm ²		750 V~ / 32 A / 4 mm ²		750 V~ / 41 A / 6 mm ²		750 V~ / 57 A / 10 mm ²	
UL / CSA		600 V~ / 20 A / AWG 22...12		600 V~ / 26 A / AWG 22...10		600 V~ / 35 A / AWG 22...8		600 V~ / 55 A / AWG 20...6	
Decapado del cable		10 mm		12 mm		12 mm		13 mm	
Capacidad de conexión									
Hilo rígido		0,5...4 mm ²		0,5...6 mm ²		0,5...10 mm ²		0,5...16 mm ²	
Cable flexible		0,5...2,5 mm ²		0,5...4 mm ²		0,5...6 mm ²		0,5...10 mm ²	
Conductor AWG		22...12		22...10		22...8		20...6	
Material plástico	Color	Referencia	Cant./Embal.	Referencia	Cant./Embal.	Referencia	Cant./Embal.	Referencia	Cant./Embal.
	Gris	BTWI 2,5	100	BTWI 4	100	BTWI 6	100	BTWI 10	100
	Azul	BTWI 2,5-AZ	100	BTWI 4-AZ	100	BTWI 6-AZ	100	BTWI 10-AZ	100
	Verde	BTWI 2,5-VD	100	BTWI 4-VD	100	BTWI 6-VD	100	BTWI 10-VD	100
	Rojo	BTWI 2,5-VM	100	BTWI 4-VM	100	BTWI 6-VM	100	BTWI 10-VM	100
Tapa terminal	Color	Referencia	Cant./Embal.	Referencia	Cant./Embal.	Referencia	Cant./Embal.	Referencia	Cant./Embal.
	Gris	TF-BTWI 2,5	100	TF-BTWI 4	100	TF-BTWI 6	100	TF-BTWI 10	100
	Azul	TF-BTWI 2,5-AZ	100	TF-BTWI 4-AZ	100	TF-BTWI 6-AZ	100	TF-BTWI 10-AZ	100
	Verde	TF-BTWI 2,5-VD	100	TF-BTWI 4-VD	100	TF-BTWI 6-VD	100	TF-BTWI 10-VD	100
	Rojo	TF-BTWI 2,5-VM	100	TF-BTWI 4-VM	100	TF-BTWI 6-VM	100	TF-BTWI 10-VM	100
Puente conectora	Nr. polos	Referencia	Cant./Embal.	Referencia	Cant./Embal.	Referencia	Cant./Embal.	Referencia	Cant./Embal.
	2	PC-BTWM 2,5/2	25	PC-BTWM 4/2	25	PC-BTWM 6/2	25	PC-BTWM 10/2	25
	3	PC-BTWM 2,5/3	20	PC-BTWM 4/3	20	PC-BTWM 6/3	20	PC-BTWM 10/3	20
	4	PC-BTWM 2,5/4	15	PC-BTWM 4/4	15	PC-BTWM 6/4	15	PC-BTWM 10/4	15
	10	PC-BTWM 2,5/10	5	PC-BTWM 4/10	5	PC-BTWM 6/10	5	PC-BTWM 10/10	5
Tope final	Color	Referencia	Cant./Embal.	Referencia	Cant./Embal.	Referencia	Cant./Embal.	Referencia	Cant./Embal.
	Gris	PF3-BTW	100	PF3-BTW	100	PF3-BTW	100	PF3-BTW	100
	Gris	PF4-BTW	100	PF4-BTW	100	PF4-BTW	100	PF4-BTW	100
	Gris	PF5-BTW	100	PF5-BTW	100	PF5-BTW	100	PF5-BTW	100
Riel / Soporte	Tipo	Referencia	Cant./Embal.	Referencia	Cant./Embal.	Referencia	Cant./Embal.	Referencia	Cant./Embal.
	Riel	MR 35x7,5	Barras 2 m	MR 35x7,5	Barras 2 m	MR 35x7,5	Barras 2 m	MR 35x7,5	2 m
	Soporte	ST-BTW	25	ST-BTW	25	ST-BTW	25	ST-BTW	25
Identificador de grupo	Color	Referencia	Cant./Embal.	Referencia	Cant./Embal.	Referencia	Cant./Embal.	Referencia	Cant./Embal.
	Gris	IG-BTW	50	IG-BTW	50	IG-BTW	50	IG-BTW	50
	Transp.	IG22-BTW ¹⁾	25	IG22-BTW ¹⁾	25	IG22-BTW ¹⁾	25	IG22-BTW ¹⁾	25
Identificador²⁾		Referencia	Cant./Embal.	Referencia	Cant./Embal.	Referencia	Cant./Embal.	Referencia	Cant./Embal.
		IDB5-BTW	500	IDB5-BTW	500	IDB5-BTW	500	IDB5-BTW	500
		IDG6/5-BTW	400	IDG6/5-BTW	400	IDG6/5-BTW	400	IDG6/5-BTW	400
		IDG10/5-BTW	440	IDG10/5-BTW	440	IDG10/5-BTW	440	IDG10/5-BTW	440
		-			IDG10/6-BTW	360	IDG10/6-BTW	360	IDG10/6-BTW

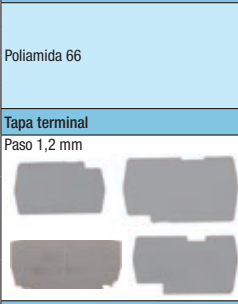
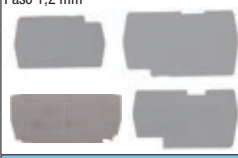
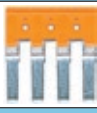
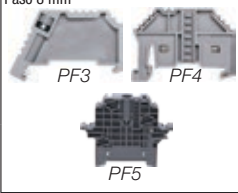
Notas: 1) Para montaje sobre el tope final PF4-BTW.
2) Mayores detalles de los identificadores en la página 48.

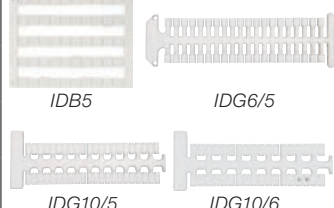
Tabla de Selección - Conexión Tipo Resorte (Push-In)

Línea BTWI - Bornes Tierra

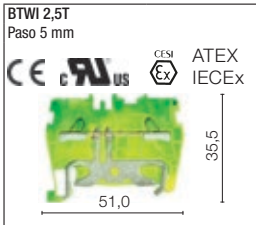
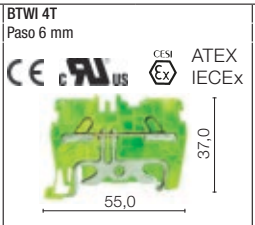
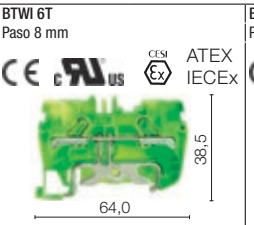
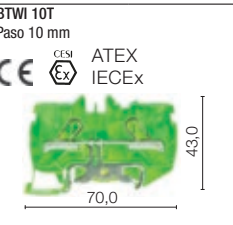
		BTWI 2,5T Paso 5 mm	BTWI 4T Paso 6 mm	BTWI 6T Paso 8 mm	BTWI 10T Paso 10 mm				
									
Datos técnicos		Sección nominal							
IEC 60947-7-1		2,5 mm ²	4 mm ²	6 mm ²	10 mm ²				
UL / CSA		AWG 22...12	AWG 22...10	AWG 22...8	AWG 20...6				
Decapado del cable		10 mm	12 mm	12 mm	13 mm				
Capacidad de conexión									
Hilo rígido		0,5...4 mm ²	0,5...6 mm ²	0,5...10 mm ²	0,5...16 mm ²				
Cable flexible		0,5...2,5 mm ²	0,5...4 mm ²	0,5...6 mm ²	0,5...10 mm ²				
Conductor AWG		22...12	22...10	22...8	20...6				
Material plástico	Color	Referencia	Cant./Embal.	Referencia	Cant./Embal.	Referencia	Cant./Embal.	Referencia	Cant./Embal.
Poliamida 66	Vd/Am	BTWI 2,5T-VD/AM	50	BTWI 4T-VD/AM	50	BTWI 6T-VD/AM	40	BTWI 10T-VD/AM	30
Tapa terminal	Color	Referencia	Cant./Embal.	Referencia	Cant./Embal.	Referencia	Cant./Embal.	Referencia	Cant./Embal.
Paso 1,2 mm	Verde	TF-BTWI 2,5 T	10	TF-BTWI 4 T	10	TF-BTWI 6 T	10	TF-BTWI 10 T	10
Tope final	Color	Referencia	Cant./Embal.	Referencia	Cant./Embal.	Referencia	Cant./Embal.	Referencia	Cant./Embal.
Paso 8 mm	Gris	PF3-BTW	100	PF3-BTW	100	PF3-BTW	100	PF3-BTW	100
	Gris	PF4-BTW	100	PF4-BTW	100	PF4-BTW	100	PF4-BTW	100
	Gris	PF5-BTW	100	PF5-BTW	100	PF5-BTW	100	PF5-BTW	100
Riel / Soporte	Tipo	Referencia	Cant./Embal.	Referencia	Cant./Embal.	Referencia	Cant./Embal.	Referencia	Cant./Embal.
DIN EN 50022	Riel	MR 35x7,5	Barras 2 m	MR 35x7,5	Barras 2 m	MR 35x7,5	Barras 2 m	MR 35x7,5	Barras 2 m
	Soporte	ST-BTW	25	ST-BTW	25	ST-BTW	25	ST-BTW	25
Identificador de grupo	Color	Referencia	Cant./Embal.	Referencia	Cant./Embal.	Referencia	Cant./Embal.	Referencia	Cant./Embal.
	Gris	IG-BTW	50	IG-BTW	50	IG-BTW	50	IG-BTW	50
	Transp.	IG22-BTW ¹⁾	25	IG22-BTW ¹⁾	25	IG22-BTW ¹⁾	25	IG22-BTW ¹⁾	25
Identificador²⁾		Referencia	Cant./Embal.	Referencia	Cant./Embal.	Referencia	Cant./Embal.	Referencia	Cant./Embal.
	IDB5	IDB5-BTW	500	IDB5-BTW	500	IDB5-BTW	500	IDB5-BTW	500
	IDG6/5	IDG6/5-BTW	400	IDG6/5-BTW	400	IDG6/5-BTW	400	IDG6/5-BTW	400
	IDG10/5	IDG10/5-BTW	440	IDG10/5-BTW	440	IDG10/5-BTW	440	IDG10/5-BTW	440
	IDG10/6	-		IDG10/6-BTW	360	IDG10/6-BTW	360	IDG10/6-BTW	360







Notas: 1) Para montaje sobre el tope final PF4-BTW.

2) Mayores detalles de los identificadores en la página 48.

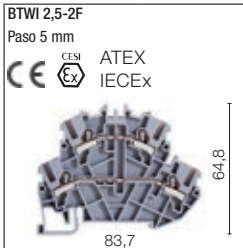
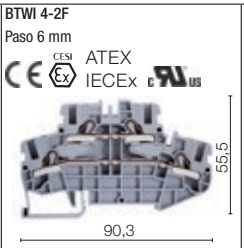
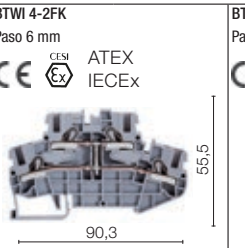
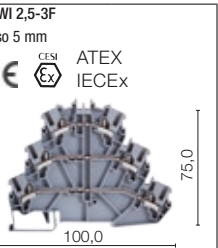
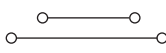
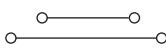

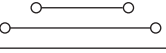
Tabla de Selección - Conexión Tipo Resorte (Push-In)

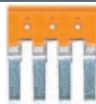
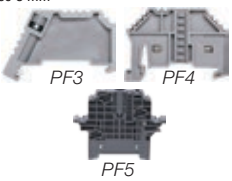
Línea BTWI - Borne Doble - Borne Triple

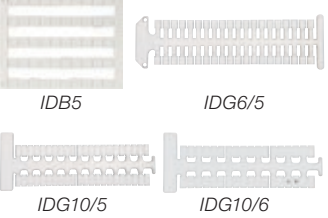
	BTWI 2,5-2F Paso 5 mm 	BTWI 4-2F Paso 6 mm 	BTWI 4-2FK Paso 6 mm 	BTWI 2,5-3F Paso 5 mm 					
Datos técnicos									
IEC 60947-7-1	500 V~ / 24 A / 2,5 mm ²	750 V~ / 30 A / 4 mm ²	750 V~ / 30 A / 4 mm ²	500 V~ / 24 A / 2,5 mm ²					
UL / CSA	600 V~ / 20 A / AWG 22...12	600 V~ / 26 A / AWG 22...10	600 V~ / 26 A / AWG 22...12	600 V~ / 20 A / AWG 22...12					
Decapado del cable	10 mm	12 mm	10 mm	10 mm					
Capacidad de conexión									
Hilo rígido	0,5...4 mm ²	0,5...6 mm ²	0,5...6 mm ²	0,5...4 mm ²					
Cable flexible	0,5...2,5 mm ²	0,5...4 mm ²	0,5...4 mm ²	0,5...2,5 mm ²					
Conductor AWG	22...12	22...10	22...10	22...12					
Material plástico	Color	Referencia	Cant./Embal.	Referencia	Cant./Embal.	Referencia	Cant./Embal.	Referencia	Cant./Embal.
Poliamida 66	Gris	BTWI 2,5-2F	50	BTWI 4-2F	50	BTWI 4-2K	50	BTWI 2,5-3F	20
Tapa terminal	Color	Referencia	Cant./Embal.	Referencia	Cant./Embal.	Referencia	Cant./Embal.	Referencia	Cant./Embal.
Paso 1,5 mm 	Gris	TF-BTWI 2,5-2F	50	TF-BTWI 4-2F	25	TF-BTWI 4-2F	50	TF-BTWI 2,5-3F	10
Puente conectora	Nr. polos	Referencia	Cant./Embal.	Referencia	Cant./Embal.	Referencia	Cant./Embal.	Referencia	Cant./Embal.
	2	PC-BTWM 2,5/2	25	PC-BTWM 4/2	25	PC-BTWM 4/2	25	PC-BTWM 2,5/2	25
	3	PC-BTWM 2,5/3	20	PC-BTWM 4/3	20	PC-BTWM 4/3	20	PC-BTWM 2,5/3	20
	4	PC-BTWM 2,5/4	15	PC-BTWM 4/4	15	PC-BTWM 4/4	15	PC-BTWM 2,5/4	15
	10	PC-BTWM 2,5/10	5	PC-BTWM 4/10	5	PC-BTWM 4/10	5	PC-BTWM 2,5/10	5
Tope final	Color	Referencia	Cant./Embal.	Referencia	Cant./Embal.	Referencia	Cant./Embal.	Referencia	Cant./Embal.
Paso 8 mm 	Gris	PF3-BTW	100	PF3-BTW	100	PF3-BTW	100	PF3-BTW	100
	Gris	PF4-BTW	100	PF4-BTW	100	PF4-BTW	100	PF4-BTW	100
	Gris	PF5-BTW	100	PF5-BTW	100	PF5-BTW	100	PF5-BTW	100
Riel / Soporte	Tipo	Referencia	Cant./Embal.	Referencia	Cant./Embal.	Referencia	Cant./Embal.	Referencia	Cant./Embal.
DIN EN 50022 	Riel	MR 35x7,5	Barras 2 m	MR 35x7,5	Barras 2 m	MR 35x7,5	Barras 2 m	MR 35x7,5	Barras 2 m
	Soporte	ST-BTW	25	ST-BTW	25	ST-BTW	25	ST-BTW	25
Identificador de grupo	Color	Referencia	Cant./Embal.	Referencia	Cant./Embal.	Referencia	Cant./Embal.	Referencia	Cant./Embal.
	Gris	IG-BTW	50	IG-BTW	50	IG-BTW	50	IG-BTW	50
	Transp.	IG22-BTW ¹⁾	25	IG22-BTW ¹⁾	25	IG22-BTW ¹⁾	25	IG22-BTW ¹⁾	25
Identificador²⁾	Referencia	Cant./Embal.	Referencia	Cant./Embal.	Referencia	Cant./Embal.	Referencia	Cant./Embal.	
	IDB5-BTW	500	IDB5-BTW	500	IDB5-BTW	500	IDB5-BTW	500	
	-	-	IDG6/5-BTW	400	IDG6/5-BTW	400	-	-	
	IDG10/5-BTW	440	IDG10/5-BTW	440	IDG10/5-BTW	440	IDG10/5-BTW	440	
	-	-	IDG10/6-BTW	360	IDG10/6-BTW	360	-	-	

Notas: 1) Para montaje sobre el tope final PF4-BTW.
2) Mayores detalles de los identificadores en la página 48.

Tabla de Selección - Conexión Tipo Resorte (Push-In)

Línea BTWI - Borne Doble + Tierra - Borne Triple + Tierra - Bornes para Sensores







		BTWI 2,5-2FT Paso 5 mm CE ATEX Ex IECEX	BTWI 2,5-3FT Paso 5 mm CE ATEX Ex IECEX	BTWI 3S Paso 5 mm CE ATEX Ex IECEX			
Datos técnicos							
		Tensión / Corriente / Sección nominal					
IEC 60947-7-1		500 V~ / 24 A / 2,5 mm ²	500 V~ / 24 A / 2,5 mm ²	500 V~ / 24 A / 2,5 mm ²			
UL / CSA		600 V~ / 20 A / AWG 22...12	600 V~ / 20 A / AWG 22...12	-			
Decapado del cable		10 mm	10 mm	10 mm			
Capacidad de conexión							
Hilo rígido		0,5...4 mm ²	0,5...4 mm ²	0,5...4 mm ²			
Cable flexible		0,5...2,5 mm ²	0,5...2,5 mm ²	0,5...2,5 mm ²			
Conductor AWG		22...12	22...12	22...12			
Material plástico	Color	Referencia	Cant./Embal.	Referencia	Cant./Embal.	Referencia	Cant./Embal.
Poliamida 66	Gris	BTWI 2,5-2FT	20	BTWI 2,5-3FT	20	BTWI 3S	20
Tapa terminal	Color	Referencia	Cant./Embal.	Referencia	Cant./Embal.	Referencia	Cant./Embal.
Paso 1,5 mm	Gris	TF-BTWI 2,5-2F	10	TF-BTWI 2,5-3FT	10	TF-BTWI 3S	10
Puente conectora	Nr. polos	Referencia	Cant./Embal.			Referencia	Cant./Embal.
	2	PC-BTWM 2,5/2	25			PC-BTWM 2,5/2	25
	3	PC-BTWM 2,5/3	20			PC-BTWM 2,5/3	20
	4	PC-BTWM 2,5/4	15			PC-BTWM 2,5/4	15
	10	PC-BTWM 2,5/10	5			PC-BTWM 2,5/10	5
Tope final	Color	Referencia	Cant./Embal.	Referencia	Cant./Embal.	Referencia	Cant./Embal.
Paso 8 mm 	Gris	PF3-BTW	100	PF3-BTW	100	PF3-BTW	100
	Gris	PF4-BTW	100	PF4-BTW	100	PF4-BTW	100
	Gris	PF5-BTW	100	PF5-BTW	100	PF5-BTW	100
Riel / Soporte	Tipo	Referencia	Cant./Embal.	Referencia	Cant./Embal.	Referencia	Cant./Embal.
DIN EN 50022 	Riel	MR 35x7,5	Barras 2 m	MR 35x7,5	Barras 2 m	MR 35x7,5	Barras 2 m
	Soporte	ST-BTW	25	ST-BTW	25	ST-BTW	25
Identificador de grupo	Color	Referencia	Cant./Embal.	Referencia	Cant./Embal.	Referencia	Cant./Embal.
	Gris	IG-BTW	50	IG-BTW	50	IG-BTW	50
	Transp.	IG22-BTW ¹⁾	25	IG22-BTW ¹⁾	25	IG22-BTW ¹⁾	25
Identificador²⁾		Referencia	Cant./Embal.	Referencia	Cant./Embal.	Referencia	Cant./Embal.
		IDB5-BTW	500	IDB5-BTW	500	IDB5-BTW	500
		IDG10/5-BTW	440	IDG10/5-BTW	440	IDG10/5-BTW	440

Notas: 1) Para montaje sobre el tope final PF4-BTW.

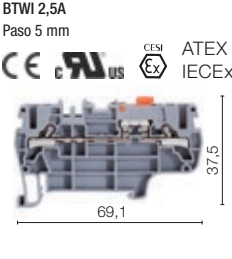
2) Mayores detalles de los identificadores en la página 48.

Tabla de Selección - Conexión Tipo Resorte (*Push-In*)

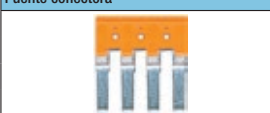
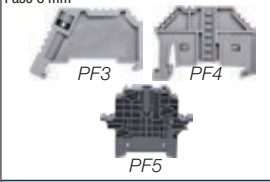

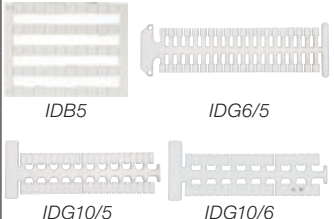



Línea BTWI - Borne Seccionable - Bornes para Fusibles

		BTWI 2,5A Paso 5 mm 	BTWI S Paso 8 mm 	BTWI SLD Paso 8 mm 	BTWI I Paso 8 mm 		
Datos técnicos	Tensión / Corriente / Sección nominal	750 V~ / 16 A / 2,5 mm ²	500 V~ / 10 A / 4 mm ²	750 V~ / 30 A / 4 mm ²	500 V~ / 10 A / 4 mm ²		
	IEC 60947-7-1	600 V~ / 10 A / AWG 22...12	600 V~ / 10 A / AWG 22...10	600 V~ / 26 A / AWG 22...12	600 V~ / 10 A / AWG 22...10		
	UL / CSA	-	5x20 or 5x25 mm	5x20 or 5x25 mm	6,35x31,75 mm (1/4"x1 1/4")		
	Dimensiones del fusible	10 mm	12 mm	10 mm	12 mm		
	Decapado del cable	Capacidad de conexión					
	Hilo rígido	0,5...4 mm ²	0,5...6 mm ²	0,5...6 mm ²	0,5...6 mm ²		
	Cable flexible	0,5...2,5 mm ²	0,5...4 mm ²	0,5...4 mm ²	0,5...4 mm ²		
	Conductor AWG	22...12	22...10	22...10	22...10		
Material plástico	Color	Referencia	Cant./Embal.	Referencia	Cant./Embal.		
Poliamida 66	Gris	BTWI 2,5A	50	BTWI S	20		
		Nota: fusible reserva incluido.		BTWI SLD C03 - 24 V cc BTWI SLD D13 - 110 V ca BTWI SLD D23 - 220 V ca	20	Nota: fusible reserva incluido.	
Tapa terminal	Color	Referencia	Cant./Embal.	Referencia	Cant./Embal.		
Paso 1,5 mm 	Gris	TF-BTWI 2,5A	10	Incorporado	Incorporado	Incorporado	
Puente conectora	Nr. polos	Referencia	Cant./Embal.	Referencia	Cant./Embal.	Referencia	Cant./Embal.
	2	PC-BTWM 2,5/2	25	PC-BTWM 6/2	25	PC-BTWM 4/2	25
	3	PC-BTWM 2,5/3	20	PC-BTWM 6/3	20	PC-BTWM 4/3	20
	4	PC-BTWM 2,5/4	15	PC-BTWM 6/4	15	PC-BTWM 4/4	15
	10	PC-BTWM 2,5/10	5	PC-BTWM 6/10	5	PC-BTWM 4/10	5
Topo final	Color	Referencia	Cant./Embal.	Referencia	Cant./Embal.	Referencia	Cant./Embal.
Paso 8 mm 	Gris	PF3-BTW	100	PF3-BTW	100	PF3-BTW	100
	Gris	PF4-BTW	100	PF4-BTW	100	PF4-BTW	100
	Gris	PF5-BTW	100	PF5-BTW	100	PF5-BTW	100
Riel / Soporte	Tipo	Referencia	Cant./Embal.	Referencia	Cant./Embal.	Referencia	Cant./Embal.
DIN EN 50022 	Riel	MR 35x7,5	Barras 2 m	MR 35x7,5	Barras 2 m	MR 35x7,5	Barras 2 m
	Soporte	ST-BTW	25	ST-BTW	25	ST-BTW	25
Identificador de grupo	Color	Referencia	Cant./Embal.	Referencia	Cant./Embal.	Referencia	Cant./Embal.
	Gris	IG-BTW	50	IG-BTW	50	IG-BTW	50
	Transp.	IG22-BTW ¹⁾	25	IG22-BTW ¹⁾	25	IG22-BTW ¹⁾	25
Identificador ²⁾		Referencia	Cant./Embal.	Referencia	Cant./Embal.	Referencia	Cant./Embal.
	IDB5	IDB5-BTW	500	IDB5-BTW	500	IDB5-BTW	500
	IDG6/5	IDG6/5-BTW	400	-	IDG6/5-BTW	400	-
	IDG10/5	IDG10/5-BTW	440	IDG10/5-BTW	440	IDG10/5-BTW	440
	IDG10/6	-	IDG10/6-BTW	360	IDG10/6-BTW	360	IDG10/6-BTW

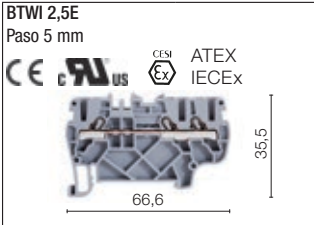
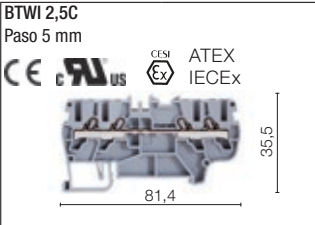
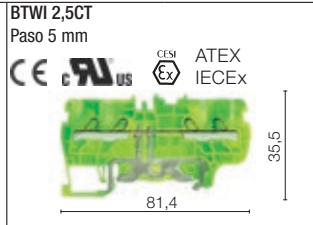
Notas: 1) Para montaje sobre el topo final PF4-BTW.
2) Mayores detalles de los identificadores en la página 48.

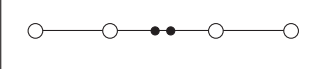
Tabla de Selección - Conexión Tipo Resorte (Push-In)

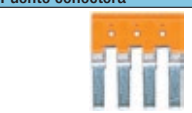
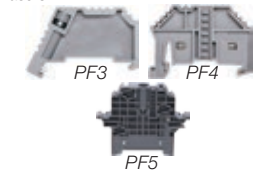
Línea BTWI - Borne 1In-2Out - Borne 2In-2Out - Borne Tierra Doble

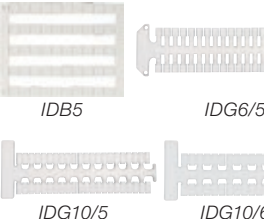
		BTWI 2,5E Paso 5 mm		BTWI 2,5C Paso 5 mm		BTWI 2,5CT Paso 5 mm	
							
Datos técnicos							
		Tensión / Corriente / Sección nominal		Tensión / Corriente / Sección nominal		Sección nominal	
IEC 60947-7-1		750 V~ / 24 A / 2,5 mm ²		750 V~ / 24 A / 2,5 mm ²		2,5 mm ²	
UL / CSA		600 V~ / 20 A / AWG 22...12		600 V~ / 20 A / AWG 22...12		AWG 22...12	
Decapado del cable		13 mm		13 mm		13 mm	
Capacidad de conexión							
Hilo rígido		0,5...4 mm ²		0,5...4 mm ²		0,5...4 mm ²	
Cable flexible		0,5...2,5 mm ²		0,5...2,5 mm ²		0,5...2,5 mm ²	
Conductor AWG		22...12		22...12		22...12	
Material plástico	Color	Referencia	Cant./Embal.	Referencia	Cant./Embal.	Referencia	Cant./Embal.
Poliamida 66	Gris	BTWI 2,5E	50	BTWI 2,5C	50	-	-
	Verde	-	-	-	-	BTWI 2,5CT	50
Tapa terminal	Color	Referencia	Cant./Embal.	Referencia	Cant./Embal.	Referencia	Cant./Embal.
Paso 1,2 mm 	Gris	TF-BTWI 2,5E	10	TF-BTWI 2,5C	10	-	-
	Verde	-	-	-	-	TF-BTWI 2,5CT	10
Puente conectora	Nr. polos	Referencia	Cant./Embal.	Referencia	Cant./Embal.	Referencia	Cant./Embal.
	2	PC-BTWM 2,5/2	25	PC-BTWM 2,5/2	25	-	-
	3	PC-BTWM 2,5/3	20	PC-BTWM 2,5/3	20	-	-
	4	PC-BTWM 2,5/4	15	PC-BTWM 2,5/4	15	-	-
	10	PC-BTWM 2,5/10	5	PC-BTWM 2,5/10	5	-	-
Tope final	Color	Referencia	Cant./Embal.	Referencia	Cant./Embal.	Referencia	Cant./Embal.
Paso 8 mm 	Gris	PF3-BTW	100	PF3-BTW	100	PF3-BTW	100
	Gris	PF4-BTW	100	PF4-BTW	100	PF4-BTW	100
	Gris	PF5-BTW	100	PF5-BTW	100	PF5-BTW	100
Riel / Soporte	Tipo	Referencia	Cant./Embal.	Referencia	Cant./Embal.	Referencia	Cant./Embal.
DIN EN 50022 	Riel	MR 35x7,5	Barras 2 m	MR 35x7,5	Barras 2 m	MR 35x7,5	Barras 2 m
	Soporte	ST-BTW	25	ST-BTW	25	ST-BTW	25
Identificador de grupo	Color	Referencia	Cant./Embal.	Referencia	Cant./Embal.	Referencia	Cant./Embal.
	Gris	IG-BTW	50	IG-BTW	50	IG-BTW	50
	Transp.	IG22-BTW ¹⁾	25	IG22-BTW ¹⁾	25	IG22-BTW ¹⁾	25
Identificador²⁾		Referencia	Cant./Embal.	Referencia	Cant./Embal.	Referencia	Cant./Embal.
		IDB5-BTW	500	IDB5-BTW	500	IDB5-BTW	500
		IDG6/5-BTW	400	IDG6/5-BTW	400	IDG6/5-BTW	400
		IDG10/5-BTW	440	IDG10/5-BTW	440	IDG10/5-BTW	440

Notas: 1) Para montaje sobre el tope final PF4-BTW.

2) Mayores detalles de los identificadores en la página 48.

Línea BTWM - Conexión Tipo Resorte

Los bornes de la línea BTWM utilizan la técnica de conexión tipo resorte. En este sistema muy sencillo, pero eficaz, la conexión es mantenida por un resorte de acero inoxidable que presiona constantemente el conductor contra el elemento interno de cobre.

El procedimiento de conexión es sencillo: se remueve el aislamiento del conductor, se inserta un destornillador en el agujero cuadrado del borne para que el resorte se comprima, liberando el acceso y entonces se inserta el conductor en el borne.

Con la remoción de del destornillador, la conexión es efectuada. La presión de contacto en este sistema de conexión es uniforme e independiente del usuario/operador, pues es dada por el resorte.

Características Principales de los Bornes de la Línea BTWM

- Cuerpo del borne en poliamida PA, con excelentes propiedades dieléctricas y alta resistencia mecánica
- Elemento conductor interno de elevada capacidad de conducción de corriente
- Resorte de acero inoxidable
- Presión de contacto uniforme







Tabla de Selección - Conexión Tipo Resorte

Línea BTWM - Bornes Terminales con Contacto Tipo Resorte

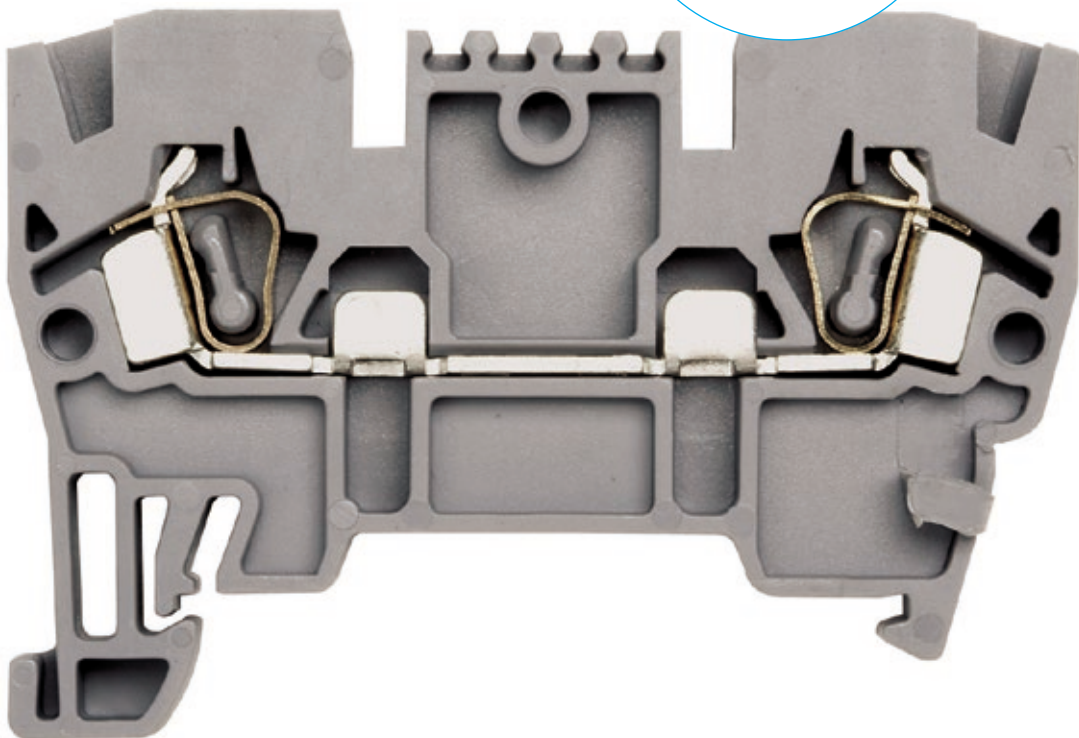
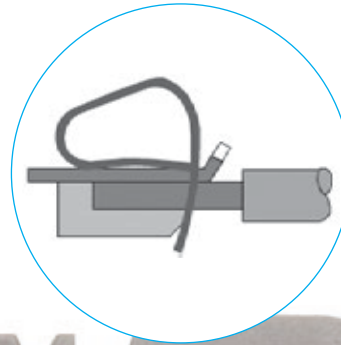
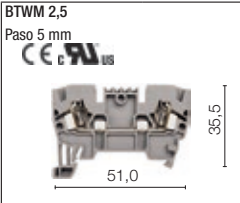
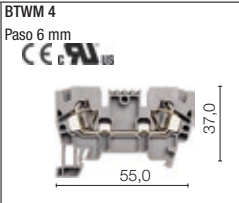
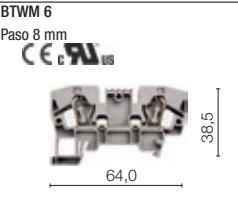
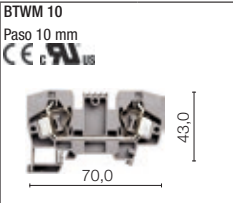
		BTWM 2,5 Paso 5 mm		BTWM 4 Paso 6 mm		BTWM 6 Paso 8 mm		BTWM 10 Paso 10 mm	
									
Datos técnicos		Tensión / Corriente / Sección nominal							
IEC 60947-7-1		750 V~ / 24 A / 2,5 mm ²		750 V~ / 32 A / 4 mm ²		750 V~ / 41 A / 6 mm ²		750 V~ / 57 A / 10 mm ²	
UL / CSA		600 V~ / 20 A / AWG 22...12		600 V~ / 26 A / AWG 22...10		600 V~ / 35 A / AWG 22...8		600 V~ / 55 A / AWG 20...6	
Decapado del cable		10 mm		12 mm		12 mm		13 mm	
Capacidad de conexión									
Hilo rígido		0,5...4 mm ²		0,5...6 mm ²		0,5...10 mm ²		0,5...16 mm ²	
Cable flexible		0,5...2,5 mm ²		0,5...4 mm ²		0,5...6 mm ²		0,5...10 mm ²	
Conductor AWG		22...12		22...10		22...8		20...6	
Material plástico	Color	Referencia	Cant./Embal.	Referencia	Cant./Embal.	Referencia	Cant./Embal.	Referencia	Cant./Embal.
Poliamida 66	Gris	BTWM 2,5	100	BTWM 4	100	BTWM 6	100	BTWM 10	100
	Azul	BTWM 2,5-AZ	100	BTWM 4-AZ	100	BTWM 6-AZ	100	BTWM 10-AZ	100
	Verde	BTWM 2,5-VD	100	BTWM 4-VD	100	BTWM 6-VD	100	BTWM 10-VD	100
	Rojo	BTWM 2,5-VM	100	BTWM 4-VM	100	BTWM 6-VM	100	BTWM 10-VM	100
Tapa terminal	Color	Referencia	Cant./Embal.	Referencia	Cant./Embal.	Referencia	Cant./Embal.	Referencia	Cant./Embal.
Paso 1,2 mm 	Gris	TF-BTWM 2,5	100	TF-BTWM 4	100	TF-BTWM 6	100	TF-BTWM 10	100
	Azul	TF-BTWM 2,5-AZ	100	TF-BTWM 4-AZ	100	TF-BTWM 6-AZ	100	TF-BTWM 10-AZ	100
	Verde	TF-BTWM 2,5-VD	100	TF-BTWM 4-VD	100	TF-BTWM 6-VD	100	TF-BTWM 10-VD	100
	Rojo	TF-BTWM 2,5-VM	100	TF-BTWM 4-VM	100	TF-BTWM 6-VM	100	TF-BTWM 10-VM	100
Puente conectora	Nr. polos	Referencia	Cant./Embal.	Referencia	Cant./Embal.	Referencia	Cant./Embal.	Referencia	Cant./Embal.
	2	PC-BTWM 2,5/2	25	PC-BTWM 4/2	25	PC-BTWM 6/2	25	PC-BTWM 10/2	25
	3	PC-BTWM 2,5/3	20	PC-BTWM 4/3	20	PC-BTWM 6/3	20	PC-BTWM 10/3	20
	4	PC-BTWM 2,5/4	15	PC-BTWM 4/4	15	PC-BTWM 6/4	15	PC-BTWM 10/4	15
	10	PC-BTWM 2,5/10	5	PC-BTWM 4/10	5	PC-BTWM 6/10	5	PC-BTWM 10/10	5
Tope final	Color	Referencia	Cant./Embal.	Referencia	Cant./Embal.	Referencia	Cant./Embal.	Referencia	Cant./Embal.
Paso 8 mm 	Gris	PF3-BTW	100	PF3-BTW	100	PF3-BTW	100	PF3-BTW	100
	Gris	PF4-BTW	100	PF4-BTW	100	PF4-BTW	100	PF4-BTW	100
	Gris	PF5-BTW	100	PF5-BTW	100	PF5-BTW	100	PF5-BTW	100
Riel / Soporte	Tipo	Referencia	Cant./Embal.	Referencia	Cant./Embal.	Referencia	Cant./Embal.	Referencia	Cant./Embal.
DIN EN 50022 	Riel	MR 35x7,5	Barras 2 m	MR 35x7,5	Barras 2 m	MR 35x7,5	Barras 2 m	MR 35x7,5	Barras 2 m
	Soporte	ST-BTW	25	ST-BTW	25	ST-BTW	25	ST-BTW	25
Identificador de grupo	Color	Referencia	Cant./Embal.	Referencia	Cant./Embal.	Referencia	Cant./Embal.	Referencia	Cant./Embal.
	Gris	IG-BTW	50	IG-BTW	50	IG-BTW	50	IG-BTW	50
	Transp.	IG22-BTW ¹⁾	25	IG22-BTW ¹⁾	25	IG22-BTW ¹⁾	25	IG22-BTW ¹⁾	25
Identificador²⁾		Referencia	Cant./Embal.	Referencia	Cant./Embal.	Referencia	Cant./Embal.	Referencia	Cant./Embal.
		IDB5-BTW	500	IDB5-BTW	500	IDB5-BTW	500	IDB5-BTW	500
		IDG6/5-BTW	400	IDG6/5-BTW	400	IDG6/5-BTW	400	IDG6/5-BTW	400
		IDG10/5-BTW	440	IDG10/5-BTW	440	IDG10/5-BTW	440	IDG10/5-BTW	440
		-		IDG10/6-BTW	360	IDG10/6-BTW	360	IDG10/6-BTW	360

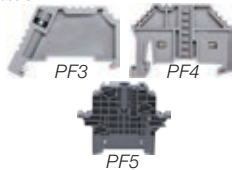
Notas: 1) Para montaje sobre el tope final PF4-BTW.

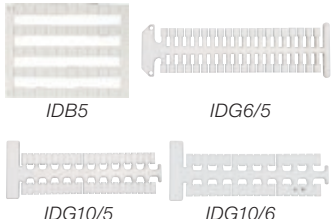
2) Mayores detalles de los identificadores en la página 48.

Tabla de Selección - Conexión Tipo Resorte





Línea BTWM - Bornes Tierra

		BTWM 2,5T Paso 5 mm	BTWM 4T Paso 6 mm	BTWM 6T Paso 8 mm	BTWM 10T Paso 10 mm				
									
		51,0	55,0	64,0	70,0				
		35,5	37,0	38,5	43,0				
Datos técnicos		Sección nominal							
IEC 60947-7-1		2,5 mm ²	4 mm ²	6 mm ²	10 mm ²				
UL / CSA		AWG 22...12	AWG 22...10	AWG 22...8	AWG 20...6				
Decapado del cable		10 mm	12 mm	12 mm	13 mm				
Capacidad de conexión									
Hilo rígido		0,5...4 mm ²	0,5...6 mm ²	0,5...10 mm ²	0,5...16 mm ²				
Cable flexible		0,5...2,5 mm ²	0,5...4 mm ²	0,5...6 mm ²	0,5...10 mm ²				
Conductor AWG		22...12	22...10	22...8	20...6				
Material plástico	Color	Referencia	Cant./Embal.	Referencia	Cant./Embal.	Referencia	Cant./Embal.	Referencia	Cant./Embal.
Poliamida 66	Verde	BTWM 2,5T-VD/AM	50	BTWM 4T-VD/AM	50	BTWM 6T-VD/AM	40	BTWM 10T-VD/AM	30
Tapa terminal	Color	Referencia	Cant./Embal.	Referencia	Cant./Embal.	Referencia	Cant./Embal.	Referencia	Cant./Embal.
Paso 1,2 mm	Verde	TF-BTWM 2,5 T	10	TF-BTWM 4 T	10	TF-BTWM 6 T	10	TF-BTWM 10 T	10
Tope final	Color	Referencia	Cant./Embal.	Referencia	Cant./Embal.	Referencia	Cant./Embal.	Referencia	Cant./Embal.
Paso 8 mm	Gris	PF3-BTW	100	PF3-BTW	100	PF3-BTW	100	PF3-BTW	100
	Riel	PF4-BTW	100	PF4-BTW	100	PF4-BTW	100	PF4-BTW	100
	Riel	PF5-BTW	100	PF5-BTW	100	PF5-BTW	100	PF5-BTW	100
Riel / Soporte	Tipo	Referencia	Cant./Embal.	Referencia	Cant./Embal.	Referencia	Cant./Embal.	Referencia	Cant./Embal.
DIN EN 50022	Riel	MR 35x7,5	2 m	MR 35x7,5	Barras 2 m	MR 35x7,5	Barras 2 m	MR 35x7,5	Barras 2 m
	Soporte	ST-BTW	25	ST-BTW	25	ST-BTW	25	ST-BTW	25
Identificador de grupo	Color	Referencia	Cant./Embal.	Referencia	Cant./Embal.	Referencia	Cant./Embal.	Referencia	Cant./Embal.
	Gris	IG-BTW	50	IG-BTW	50	IG-BTW	50	IG-BTW	50
	Transp.	IG22-BTW ¹⁾	25	IG22-BTW ¹⁾	25	IG22-BTW ¹⁾	25	IG22-BTW ¹⁾	25
Identificador²⁾		Referencia	Cant./Embal.	Referencia	Cant./Embal.	Referencia	Cant./Embal.	Referencia	Cant./Embal.
	IDB5	IDB5-BTW	500	IDB5-BTW	500	IDB5-BTW	500	IDB5-BTW	500
	IDG6/5	IDG6/5-BTW	400	IDG6/5-BTW	400	IDG6/5-BTW	400	IDG6/5-BTW	400
	IDG10/5	IDG10/5-BTW	440	IDG10/5-BTW	440	IDG10/5-BTW	440	IDG10/5-BTW	440
	IDG10/6	-	-	IDG10/6-BTW	360	IDG10/6-BTW	360	IDG10/6-BTW	360

Notas: 1) Para montaje sobre el tope final PF4-BTW.
2) Mayores detalles de los identificadores en la página 48.

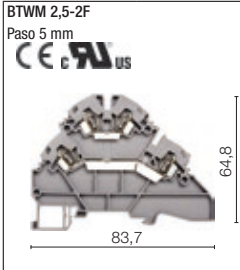
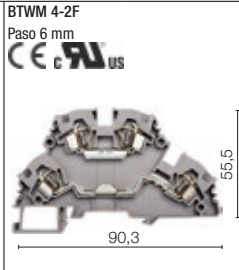
Tabla de Selección - Conexión Tipo Resorte

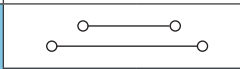
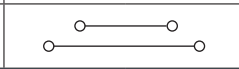
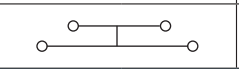
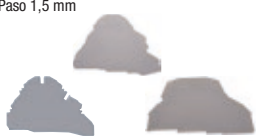
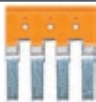
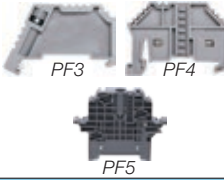
Línea BTWM - Bornes Doble - Borne Triple

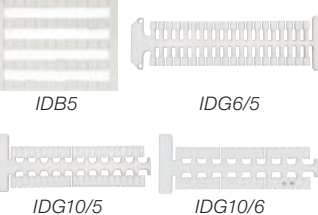





		BTWM 2,5-2F Paso 5 mm 	BTWM 4-2F Paso 6 mm 	BTWM 4-2FK Paso 6 mm 	BTWM 2,5-3F Paso 5 mm 				
Datos técnicos									
Tensión / Corriente / Sección nominal									
IEC 60947-7-1		500 V~ / 24 A / 2,5 mm ²	750 V~ / 30 A / 4 mm ²	750 V~ / 30 A / 4 mm ²	500 V~ / 24 A / 2,5 mm ²				
UL / CSA		600 V~ / 20 A / AWG 22...12	600 V~ / 26 A / AWG 22...10	-	600 V~ / 20 A / AWG 22...12				
Decapado del cable		10 mm	12 mm	10 mm	10 mm				
Capacidad de conexión									
Hilo rígido		0,5...4 mm ²	0,5...6 mm ²	0,5...6 mm ²	0,5...4 mm ²				
Cable flexible		0,5...2,5 mm ²	0,5...4 mm ²	0,5...4 mm ²	0,5...2,5 mm ²				
Conductor AWG		22...12	22...10	22...10	22...12				
Material plástico	Color	Referencia	Cant./Embal.	Referencia	Cant./Embal.	Referencia	Cant./Embal.	Referencia	Cant./Embal.
Poliamida 66	Gris	BTWM 2,5-2F	50	BTWM 4-2F	50	BTWM 4-2K	50	BTWM 2,5-3F	20
Tapa terminal	Color	Referencia	Cant./Embal.	Referencia	Cant./Embal.	Referencia	Cant./Embal.	Referencia	Cant./Embal.
Paso 1,5 mm 	Gris	TF-BTWM 2,5-2F	50	TF-BTWM 4-2F	25	TF-BTWM 4-2F	50	TF-BTWM 4-2F	10
Puente conectora	Nr. polos	Referencia	Cant./Embal.	Referencia	Cant./Embal.	Referencia	Cant./Embal.	Referencia	Cant./Embal.
	2	PC-BTWM 2,5/2	25	PC-BTWM 4/2	25	PC-BTWM 4/2	25	PC-BTWM 2,5/2	25
	3	PC-BTWM 2,5/3	20	PC-BTWM 4/3	20	PC-BTWM 4/3	20	PC-BTWM 2,5/3	20
	4	PC-BTWM 2,5/4	15	PC-BTWM 4/4	15	PC-BTWM 4/4	15	PC-BTWM 2,5/4	15
	10	PC-BTWM 2,5/10	5	PC-BTWM 4/10	5	PC-BTWM 4/10	5	PC-BTWM 2,5/10	5
Tope final	Color	Referencia	Cant./Embal.	Referencia	Cant./Embal.	Referencia	Cant./Embal.	Referencia	Cant./Embal.
Paso 8 mm 	Gris	PF3-BTW	100	PF3-BTW	100	PF3-BTW	100	PF3-BTW	100
	Gris	PF4-BTW	100	PF4-BTW	100	PF4-BTW	100	PF4-BTW	100
	Gris	PF5-BTW	100	PF5-BTW	100	PF5-BTW	100	PF5-BTW	100
Riel / Soporte	Tipo	Referencia	Cant./Embal.	Referencia	Cant./Embal.	Referencia	Cant./Embal.	Referencia	Cant./Embal.
DIN EN 50022 	Riel	MR 35x7,5	Barras 2 m	MR 35x7,5	Barras 2 m	MR 35x7,5	Barras 2 m	MR 35x7,5	Barras 2 m
	Soporte	ST-BTW	25	ST-BTW	25	ST-BTW	25	ST-BTW	25
Identificador de grupo	Color	Referencia	Cant./Embal.	Referencia	Cant./Embal.	Referencia	Cant./Embal.	Referencia	Cant./Embal.
	Gris	IG-BTW	50	IG-BTW	50	IG-BTW	50	IG-BTW	50
	Transp.	IG22-BTW ¹⁾	25	IG22-BTW ¹⁾	25	IG22-BTW ¹⁾	25	IG22-BTW ¹⁾	25
Identificador²⁾		Referencia	Cant./Embal.	Referencia	Cant./Embal.	Referencia	Cant./Embal.	Referencia	Cant./Embal.
		IDB5-BTW	500	IDB5-BTW	500	IDB5-BTW	500	IDB5-BTW	500
		-	-	IDG6/5-BTW	400	IDG6/5-BTW	400	-	-
		-	-	IDG10/5-BTW	440	IDG10/5-BTW	440	-	-
		-	-	IDG10/6-BTW	360	IDG10/6-BTW	360	-	-

Notas: 1) Para montaje sobre el tope final PF4-BTW.

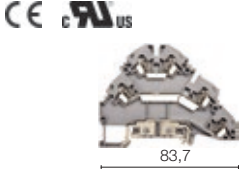
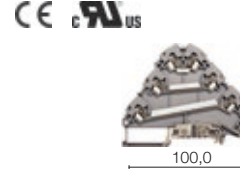
2) Mayores detalles de los identificadores en la página 48.

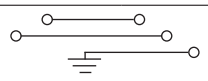
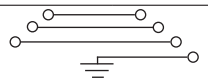
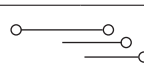
Tabla de Selección - Conexión Tipo Resorte

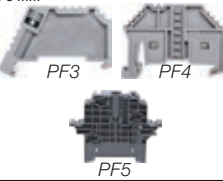

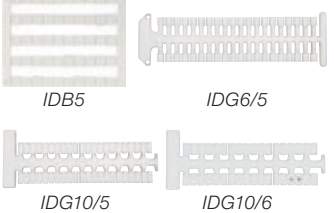





Línea BTWM - Borne Doble + Tierra - Borne Triple + Tierra - Borne para Sensores

		BTWM 2,5-2FT Paso 5 mm 	BTWM 2,5-3FT Paso 5 mm 	BTWM 3S Paso 5 mm 			
Datos técnicos							
	Tensión / Corriente / Sección nominal	500 V~ / 24 A / 2,5 mm ²	500 V~ / 24 A / 2,5 mm ²	500 V~ / 24 A / 2,5 mm ²			
IEC 60947-7-1		500 V~ / 24 A / 2,5 mm ²	500 V~ / 24 A / 2,5 mm ²	500 V~ / 24 A / 2,5 mm ²			
UL / CSA		600 V~ / 20 A / AWG 22...12	600 V~ / 20 A / AWG 22...12	-			
Decapado del cable		10 mm	10 mm	10 mm			
Capacidad de conexión							
Hilo rígido		0,5...4 mm ²	0,5...4 mm ²	0,5...4 mm ²			
Cable flexible		0,5...2,5 mm ²	0,5...2,5 mm ²	0,5...2,5 mm ²			
Conductor AWG		22...12	22...12	22...12			
Material plástico	Color	Referencia	Cant./Embal.	Referencia	Cant./Embal.	Referencia	Cant./Embal.
Poliamida 66	Gris	BTWM 2,5-2FT	20	BTWM 2,5-3FT	20	BTWM 3S	20
Tapa terminal	Color	Referencia	Cant./Embal.	Referencia	Cant./Embal.	Referencia	Cant./Embal.
Paso 1,5 mm 	Gris	TF-BTWM 2,5-2F	10	TF-BTWM 2,5-3FT	10	TF-BTWM 3S	10
Puente conectora	Nr. polos	Referencia	Cant./Embal.	Referencia	Cant./Embal.	Referencia	Cant./Embal.
	2	PC-BTWM 2,5/2	25	PC-BTWM 2,5/2	25	PC-BTWM 2,5/2	25
	3	PC-BTWM 2,5/3	20	PC-BTWM 2,5/3	20	PC-BTWM 2,5/3	20
	4	PC-BTWM 2,5/4	15	PC-BTWM 2,5/4	15	PC-BTWM 2,5/4	15
	10	PC-BTWM 2,5/10	5	PC-BTWM 2,5/10	5	PC-BTWM 2,5/10	5
Tope final	Color	Referencia	Cant./Embal.	Referencia	Cant./Embal.	Referencia	Cant./Embal.
Paso 8 mm 	Gris	PF3-BTW	100	PF3-BTW	100	PF3-BTW	100
	Gris	PF4-BTW	100	PF4-BTW	100	PF4-BTW	100
	Gris	PF5-BTW	100	PF5-BTW	100	PF5-BTW	100
Riel / Soporte	Tipo	Referencia	Cant./Embal.	Referencia	Cant./Embal.	Referencia	Cant./Embal.
DIN EN 50022 	Riel	MR 35x7,5	Barras 2 m	MR 35x7,5	Barras 2 m	MR 35x7,5	Barras 2 m
	Soporte	ST-BTW	25	ST-BTW	25	ST-BTW	25
Identificador de grupo	Color	Referencia	Cant./Embal.	Referencia	Cant./Embal.	Referencia	Cant./Embal.
	Gris	IG-BTW	50	IG-BTW	50	IG-BTW	50
	Transp.	IG22-BTW ¹⁾	25	IG22-BTW ¹⁾	25	IG22-BTW ¹⁾	25
Identificador²⁾		Referencia	Cant./Embal.	Referencia	Cant./Embal.	Referencia	Cant./Embal.
		IDB5-BTW	500	IDB5-BTW	500	IDB5-BTW	500

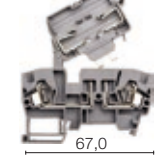
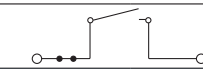
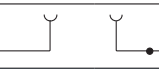
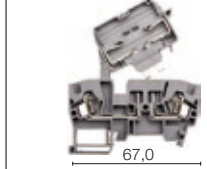
Notas: 1) Para montaje sobre el tope final PF4-BTW.
2) Mayores detalles de los identificadores en la página 48.

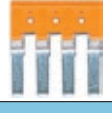
Tabla de Selección - Conexión Tipo Resorte

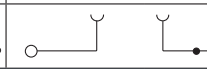
Línea BTWM - Borne Conmutable - Bornes para Fusibles

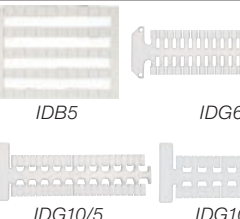







	BTWM 2,5A Paso 5 mm CE		BTWM S Paso 8 mm CE		BTWM SLD Paso 8 mm CE		BTWM I Paso 8 mm CE		
									
	37,5		64,5		64,5		64,5		
	69,1		67,0		67,0		67,0		
Datos técnicos									
	Tensión / Corriente / Sección nominal								
IEC 60947-7-1	750 V~ / 16 A / 2,5 mm ²		500 V~ / 10 A / 4 mm ²		750 V~ / 30 A / 4 mm ²		500 V~ / 10 A / 4 mm ²		
UL / CSA	600 V~ / 10 A / AWG 22...12		600 V~ / 10 A / AWG 22...10		AWG 22...12		600 V~ / 10 A / AWG 22...10		
Dimensiones del fusible	-		5x20 or 5x25 mm		5x20 or 5x25 mm		6,35x31,75 mm (1/4"x1 1/4")		
Decapado del cable	10 mm		12 mm		10 mm		12 mm		
Capacidad de conexión									
Hilo rígido	0,5...4 mm ²		0,5...6 mm ²		0,5...6 mm ²		0,5...6 mm ²		
Cable flexible	0,5...2,5 mm ²		0,5...4 mm ²		0,5...4 mm ²		0,5...4 mm ²		
Conductor AWG	22...12		22...10		22...10		22...10		
Material plástico	Color	Referencia	Cant./Embal.	Referencia	Cant./Embal.	Referencia	Cant./Embal.	Referencia	Cant./Embal.
Poliamida 66	Gris	BTWM 2,5A	50	BTWM S	20	BTWM S	20	BTWM I	20
	-	-	-	Nota: fusible reserva incluido.		BTWM SLD C03 - 24 V cc BTWM SLD D13 - 110 V ca BTWM SLD D23 - 220 V ca		Nota: fusible reserva incluido.	
Tapa terminal	Color	Referencia	Cant./Embal.	Referencia	Cant./Embal.	Referencia	Cant./Embal.	Referencia	Cant./Embal.
Paso 1,5 mm	Gris	TF-BTWM 2,5A	10	TF-BTWM S-I	10	TF-BTWM S-I	50	TF-BTWM S-I	10
Puente conectora	Nr. polos	Referencia	Cant./Embal.	Referencia	Cant./Embal.	Referencia	Cant./Embal.	Referencia	Cant./Embal.
	2	PC-BTWM 2,5/2	25	PC-BTWM 6/2	25	PC-BTWM 4/2	25	PC-BTWM 6/2	25
	3	PC-BTWM 2,5/3	20	PC-BTWM 6/3	20	PC-BTWM 4/3	20	PC-BTWM 6/3	20
	4	PC-BTWM 2,5/4	15	PC-BTWM 6/4	15	PC-BTWM 4/4	15	PC-BTWM 6/4	15
	10	PC-BTWM 2,5/10	5	PC-BTWM 6/10	5	PC-BTWM 4/10	5	PC-BTWM 6/10	5
Tope final	Color	Referencia	Cant./Embal.	Referencia	Cant./Embal.	Referencia	Cant./Embal.	Referencia	Cant./Embal.
Paso 8 mm 	Gris	PF3-BTW	100	PF3-BTW	100	PF3-BTW	100	PF3-BTW	100
	Gris	PF4-BTW	100	PF4-BTW	100	PF4-BTW	100	PF4-BTW	100
	Gris	PF5-BTW	100	PF5-BTW	100	PF5-BTW	100	PF5-BTW	100
Riel / Soporte	Tipo	Referencia	Cant./Embal.	Referencia	Cant./Embal.	Referencia	Cant./Embal.	Referencia	Cant./Embal.
DIN EN 50022 	Riel	MR 35x7,5	Barras 2 m	MR 35x7,5	Barras 2 m	MR 35x7,5	Barras 2 m	MR 35x7,5	Barras 2 m
	Soporte	ST-BTW	25	ST-BTW	25	ST-BTW	25	ST-BTW	25
Identificador de grupo	Color	Referencia	Cant./Embal.	Referencia	Cant./Embal.	Referencia	Cant./Embal.	Referencia	Cant./Embal.
	Gris	IG-BTW	50	IG-BTW	50	IG-BTW	50	IG-BTW	50
	Transp.	IG22-BTW ¹⁾	25	IG22-BTW ¹⁾	25	IG22-BTW ¹⁾	25	IG22-BTW ¹⁾	25
Identificador ²⁾	Referencia	Cant./Embal.	Referencia	Cant./Embal.	Referencia	Cant./Embal.	Referencia	Cant./Embal.	
	IDB5	IDB5-BTW	500	IDB5-BTW	500	IDB5-BTW	500	IDB5-BTW	500
	IDG6/5	IDG6/5-BTW	400	-	-	IDG6/5-BTW	400	-	-
	IDG10/5	IDG10/5-BTW	440	-	-	IDG10/5-BTW	440	-	-
	IDG10/6	-	-	-	-	IDG10/6-BTW	360	-	-

Notas: 1) Para montaje sobre el tope final PF4-BTW.

2) Mayores detalles de los identificadores en la página 48.

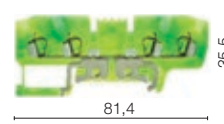
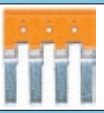
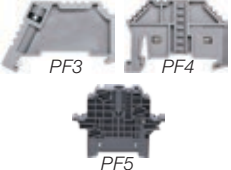
Tabla de Selección - Conexión Tipo Resorte

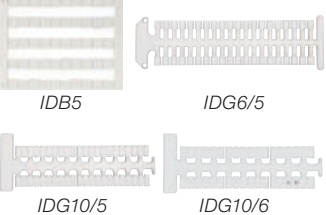
Línea BTWM - Borne 1In-2Out - Borne 2In-2Out - Borne Tierra Doble

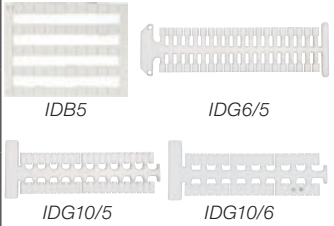
		BTWM 2,5E Paso 5 mm 	BTWM 2,5C Paso 5 mm 	BTWM 2,5CT Paso 5 mm 			
		 66,6	 81,4	 81,4			
Datos técnicos							
		Tensión / Corriente / Sección nominal		Sección nominal			
IEC 60947-7-1		750 V~ / 24 A / 2,5 mm ²	750 V~ / 24 A / 2,5 mm ²	2,5 mm ²			
UL / CSA		600 V~ / 20 A / AWG 22...12	600 V~ / 20 A / AWG 22...12	AWG 22...12			
Decapado del cable		13 mm	13 mm	13 mm			
Capacidad de conexión							
Hilo rígido		0,5...4 mm ²	0,5...4 mm ²	0,5...4 mm ²			
Cable flexible		0,5...2,5 mm ²	0,5...2,5 mm ²	0,5...2,5 mm ²			
Conductor AWG		22...12	22...12	22...12			
Material plástico	Color	Referencia	Cant./Embal.	Referencia	Cant./Embal.	Referencia	Cant./Embal.
Poliamida 66	Gris	BTWM 2,5E	50	BTWM 2,5C	50	-	-
	Verde	-	-	-	-	BTWM 2,5CT	50
Tapa terminal	Color	Referencia	Cant./Embal.	Referencia	Cant./Embal.	Referencia	Cant./Embal.
Paso 1,2 mm 	Gris	TF-BTWM 2,5E	10	TF-BTWM 2,5C	10	-	-
	Verde	-	-	-	-	TF-BTWM 2,5CT	10
Puente conectora	Nr. polos	Referencia	Cant./Embal.	Referencia	Cant./Embal.	Referencia	Cant./Embal.
	2	PC-BTWM 2,5/2	25	PC-BTWM 2,5/2	25	-	-
	3	PC-BTWM 2,5/3	20	PC-BTWM 2,5/3	20	-	-
	4	PC-BTWM 2,5/4	15	PC-BTWM 2,5/4	15	-	-
	10	PC-BTWM 2,5/10	5	PC-BTWM 2,5/10	5	-	-
Tope final	Color	Referencia	Cant./Embal.	Referencia	Cant./Embal.	Referencia	Cant./Embal.
Paso 8 mm 	Gris	PF3-BTW	100	PF3-BTW	100	PF3-BTW	100
	Gris	PF4-BTW	100	PF4-BTW	100	PF4-BTW	100
	Gris	PF5-BTW	100	PF5-BTW	100	PF5-BTW	100
Riel / Soporte	Tipo	Referencia	Cant./Embal.	Referencia	Cant./Embal.	Referencia	Cant./Embal.
DIN EN 50022 	Riel	MR 35x7,5	Barras 2 m	MR 35x7,5	Barras 2 m	MR 35x7,5	Barras 2 m
	Soporte	ST-BTW	25	ST-BTW	25	ST-BTW	25
Identificador de grupo	Color	Referencia	Cant./Embal.	Referencia	Cant./Embal.	Referencia	Cant./Embal.
	Gris	IG-BTW	50	IG-BTW	50	IG-BTW	50
	Transp.	IG22-BTW ¹⁾	25	IG22-BTW ¹⁾	25	IG22-BTW ¹⁾	25
Identificador²⁾		Referencia	Cant./Embal.	Referencia	Cant./Embal.	Referencia	Cant./Embal.
		IDB5-BTW	500	IDB5-BTW	500	IDB5-BTW	500
		IDG6/5-BTW	400	IDG6/5-BTW	400	IDG6/5-BTW	400
		IDG10/5-BTW	440	IDG10/5-BTW	440	IDG10/5-BTW	440

Notas: 1) Para montaje sobre el tope final PF4-BTW.
2) Mayores detalles de los identificadores en la página 48.

Línea BTWO - Conexión de Cables con Terminal Ojo o Horquilla

Adecuados para uso industrial, suministrando seguridad y practicidad en la conexión de cables eléctricos. El montaje de los cables es hecho con terminales tipo ojo pre-aislado. Ese recurso permite que los bornes sean utilizados en la industria siderúrgica, minería, concesionarias de energía y cubículos de media tensión.

Principales Ventajas de los Bornes de la Línea BTWO

- Cables de sección transversal
- 2 modelos: para cables con terminal tipo ojo y para cables con terminal tipo horquilla
- Aplicación en ambientes con vibración en general
- Completa línea de accesorios
- Certificaciones CE y UL

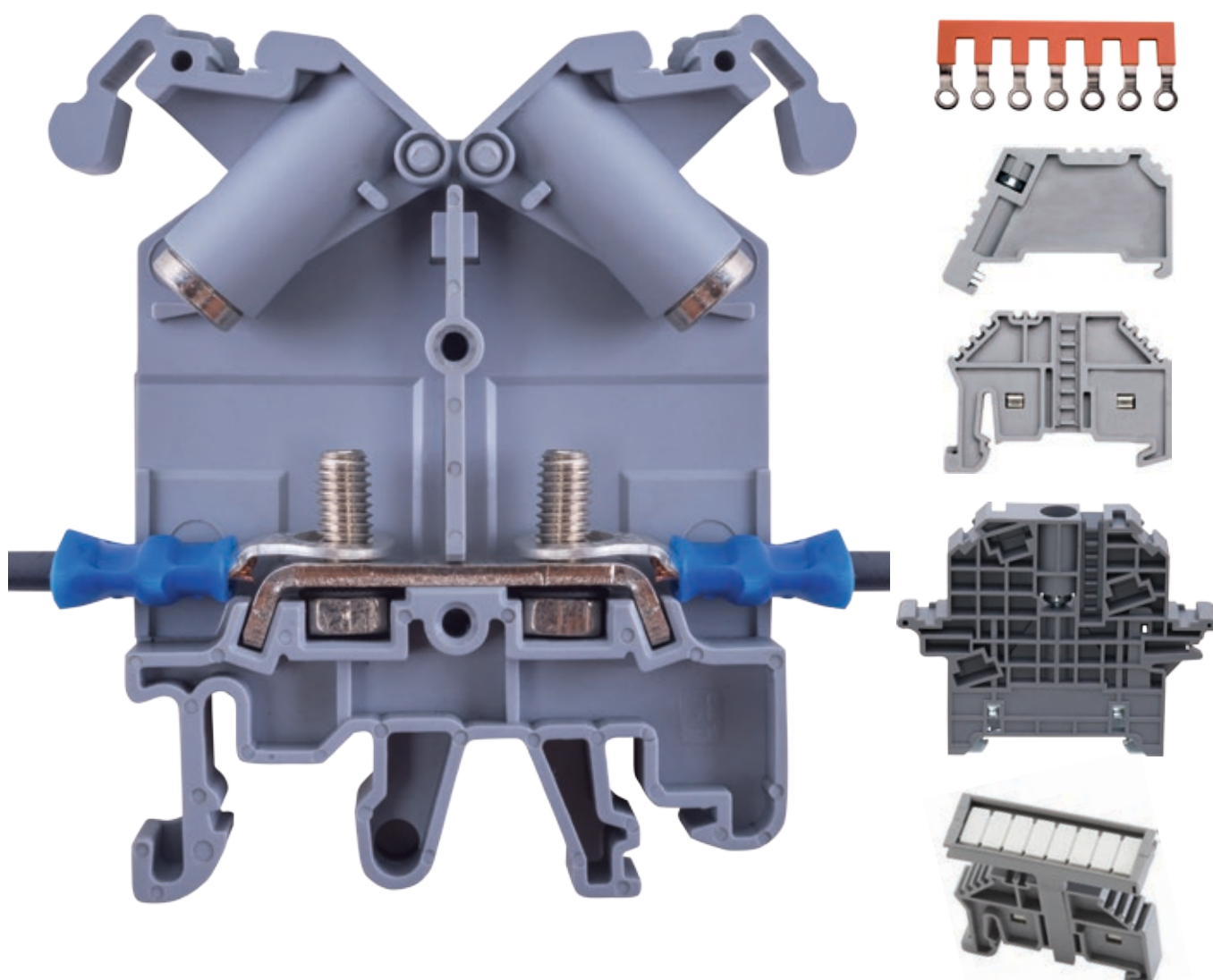









BTWO 61 - Un ejemplo de fácil montaje del cable con terminal tipo ojo

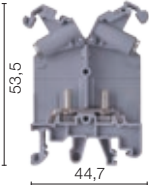
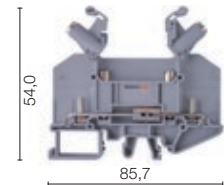
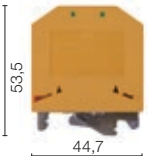
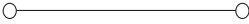

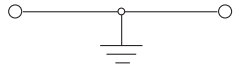
Tabla de Selección - Conexión de Cables con Terminal Ojo

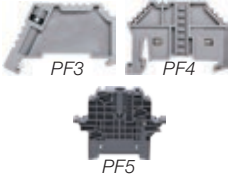

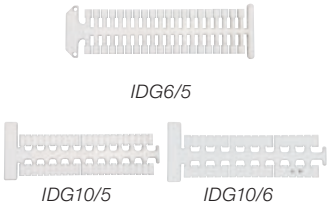

Línea BTWO - Bornes para Cables con Terminales Tipo Ojo

		BTWO 6I Paso 11 mm 	BTWO 6G - Seccionable/Teste Paso 11 mm 	BTWO 6 IT-VD/AM Paso 11 mm 			
							
Datos técnicos							
		Tensión / Corriente / Sección nominal					
IEC 60947-7-1		800 V / 41 A / 6 mm ²	500 V / 41 A / 6 mm ²	6 mm ²			
Tipo del terminal del cable		Ojo	Ojo	Ojo			
Par de apriete		0,8 Nm	0,8 Nm	0,8 Nm			
Capacidad de conexión							
Hilo rígido		0,5 - 6 mm ²	0,5 - 6 mm ²	0,5 - 6 mm ²			
Cable flexible		0,5 - 6 mm ²	0,5 - 6 mm ²	0,5 - 6 mm ²			
Conductor AWG		20...10	26...10	20...10			
Material plástico	Color	Referencia	Cant./Embal.	Referencia	Cant./Embal.	Referencia	Cant./Embal.
Poliamida 66	Gris	BTWO 6I	100	BTWO 6G	100	BTWO 6 IT-VD/AM	100
	Vd/Am						
Tapa terminal	Color	Referencia	Cant./Embal.	Referencia	Cant./Embal.	Referencia	Cant./Embal.
	Gris	TF-BTWO 6I	25	TF-BTWO 6G	25	-	25
Puente conectora	Nr. polos	Referencia	Cant./Embal.	Referencia	Cant./Embal.	Referencia	Cant./Embal.
	2	PC-BTWO 6I/2	25	PC-BTWO 6I/2	25	-	-
	3	PC-BTWO 6I/3	20	PC-BTWO 6I/3	20	-	-
	4	PC-BTWO 6I/4	15	PC-BTWO 6I/4	15	-	-
	7	PC-BTWO 6I/7	5	PC-BTWO 6I/7	5	-	-
	10	PC-BTWO 6I/10	5	PC-BTWO 6I/10	5	-	-
Tope final	Color	Referencia	Cant./Embal.	Referencia	Cant./Embal.	Referencia	Cant./Embal.
	Gris	PF3-BTW	100	PF3-BTW	100	PF3-BTW	100
	Gris	PF4-BTW	100	PF4-BTW	100	PF4-BTW	100
	Gris	PF5-BTW	100	PF5-BTW	100	PF5-BTW	100
Riel / Soporte	Tipo	Referencia	Cant./Embal.	Referencia	Cant./Embal.	Referencia	Cant./Embal.
	Riel	MR 35x7,5	Barras 2 m	MR 35x7,5	Barras 2 m	MR 35x7,5	Barras 2 m
	Soporte	ST-BTW	25	ST-BTW	25	ST-BTW	25
Identificador de grupo	Color	Referencia	Cant./Embal.	Referencia	Cant./Embal.	Referencia	Cant./Embal.
	Gris	IG-BTW	50	IG-BTW	50	IG-BTW	50
	Transp.	IG22-BTW ¹⁾	25	IG22-BTW ¹⁾	25	IG22-BTW ¹⁾	25
Identificador²⁾		Referencia	Cant./Embal.	Referencia	Cant./Embal.	Referencia	Cant./Embal.
		IDG6/5-BTW	400	IDG6/5-BTW	400	IDG6/5-BTW	400
		IDG10/5-BTW	440	IDG10/5-BTW	440	IDG10/5-BTW	440
		IDG 10/6-BTW	360	IDG 10/6-BTW	360	IDG 10/6-BTW	360

Notas: 1) Para montaje sobre el tope final PF4-BTW.
2) Mayores detalles de los identificadores en la página 48.

Tabla de Selección - Conexión de Cables con Terminal Horquilla

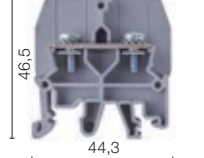
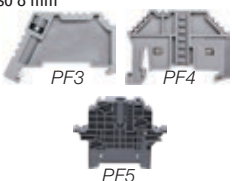
Línea BTWO - Bornes para Cables con Terminales Tipo Horquilla

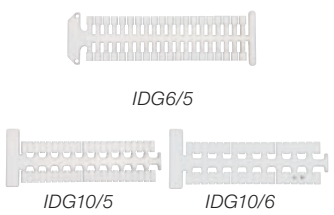
		BTWO 6 Paso 9,5 mm 		BTWO 10 Paso 13 mm 	
Datos técnicos		Tensión / Corriente / Sección nominal			
IEC 60947-7-1		800 V / 41 A / 6 mm ²		800 V / 57 A / 10 mm ²	
Tipo del terminal del cable		Horquilla		Horquilla	
Par de apriete		1,2 Nm		1,5 Nm	
Capacidad de conexión					
Hilo rígido		0,5 - 6 mm ²		0,5 - 10 mm ²	
Cable flexible		0,5 - 6 mm ²		0,5 - 10 mm ²	
Conductor AWG		20...10		20...8	
Material plástico	Color	Referencia	Cant./Embal.	Referencia	Cant./Embal.
Poliamida 66	Gris	BTWO 6	100	BTWO 10	100
Tapa terminal	Color	Referencia	Cant./Embal.	Referencia	Cant./Embal.
	Gris	TF-BTWO 6	25	TF-BTWO 10	25
Puente conectora	Nr. polos	Referencia	Cant./Embal.	Referencia	Cant./Embal.
	2	PC-BTWO 6/2	25	PC-BTWO 10/2	25
	3	PC-BTWO 6/3	20	PC-BTWO 10/3	20
	4	PC-BTWO 6/4	15	PC-BTWO 10/4	15
	7	PC-BTWO 6/7	5	PC-BTWO 10/7	5
	10	PC-BTWO 6/10	5	PC-BTWO 10/10	5
Tope final	Color	Referencia	Cant./Embal.	Referencia	Cant./Embal.
Paso 8 mm 	Gris	PF3-BTW	100	PF3-BTW	100
	Gris	PF4-BTW	100	PF4-BTW	100
	Gris	PF5-BTW	100	PF5-BTW	100
Riel / Soporte	Tipo	Referencia	Cant./Embal.	Referencia	Cant./Embal.
DIN EN 50022 	Riel	MR 35x7,5	Barras 2 m	MR 35x7,5	Barras 2 m
	Soporte	ST-BTW	25	ST-BTW	25
Identificador de grupo	Color	Referencia	Cant./Embal.	Referencia	Cant./Embal.
	Gris	IG-BTW	50	IG-BTW	50
	Transp.	IG22-BTW ¹⁾	25	IG22-BTW ¹⁾	25
Identificador²⁾		Referencia	Cant./Embal.	Referencia	Cant./Embal.
		IDG6/5-BTW	400	IDG6/5-BTW	400
		IDG10/5-BTW	440	IDG10/5-BTW	440
		IDG 10/6-BTW	360	IDG 10/6-BTW	360

Notas: 1) Para montaje sobre el tope final PF4-BTW.

2) Mayores detalles de los identificadores en la página 48.

Línea BTWR - Relé de Interfaz

Desarrollado para aplicaciones de automatización industrial para amplificación, protección, conexión y desconexión de señales en entradas y salidas digitales de CLP.

Principales Ventajas de los Relés de Interfaz de la Línea BTWR

- Disponible en las tensiones de 24/48/60/110/230 V ca/cc
- Rápida instalación
- Paso de 6,2 mm
- 1 contacto reversible
- LED indicador
- Fácil conexión del relé
- Sistema anti vibración
- Certificaciones CE y UL

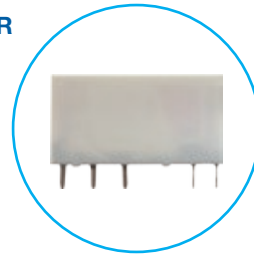

Fácil conexión y desconexión











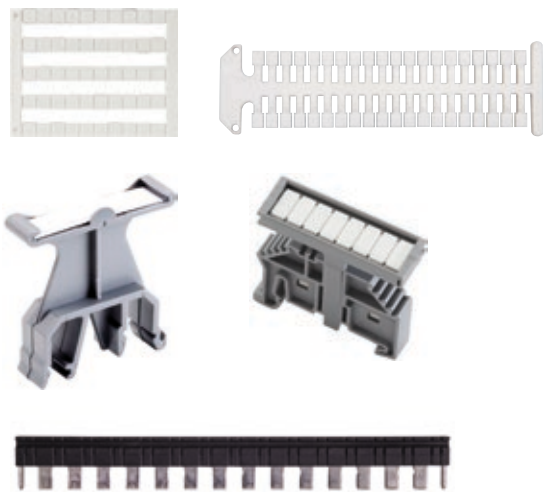

Tabla de Selección - Relé de Interfaz

Línea BTWR - Relé de Interfaz





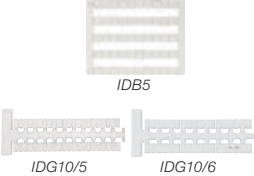









		BTWR P16E26 Paso 6,2 mm		BTWR P16E27 Paso 6,2 mm		BTWR P16E28 Paso 6,2 mm	
							
Datos técnicos		Tensión / Corriente / Sección nominal					
Tensión de la bobina		24 V ca/cc / 6 A		48 V ca/cc / 6 A		60 V ca/cc / 6 A	
Decapado del cable		8 mm		8 mm		8 mm	
Par de apriete		0,4 Nm		0,4 Nm		0,4 Nm	
Corriente y tensión de operación		6 A 250 V ca / 30 V cc					
Máxima tensión de operación		400 V ca (3,7 A) / 125 V cc (1,4 A)					
Máxima corriente de operación		6 A					
Máxima potencia de operación		1.500 VA / 180 W					
Vida mecánica		1x10 ⁷					
Vida eléctrica		NO) 3x10 ⁴ operaciones (85 °C) (NC) 1x10 ⁴ operaciones (85 °C)					
Resistencia de aislamiento		1.000 MΩ (500 V cc)					
Tiempo de operación		10ms máx.					
Señalización del relé		LED verde					
Capacidad de conexión		2,5 mm ²					
Cable flexible		2,5 mm ²					
Material plástico	Color	Referencia	Cant./Embal.	Referencia	Cant./Embal.	Referencia	Cant./Embal.
Poliamida 66	Gris	BTWR P16E26	10	BTWR P16E27	10	BTWR P16E28	10
Puente conectora	Color	Referencia	Cant./Embal.	Referencia	Cant./Embal.	Referencia	Cant./Embal.
	Gris	PC-BTWR 2,5/16R	50	PC-BTWR 2,5/16R	50	PC-BTWR 2,5/16R	50
Base relé		Referencia	Cant./Embal.	Referencia	Cant./Embal.	Referencia	Cant./Embal.
		BR-BTWR 2,5/1R E26	1	BR-BTWR 2,5/1R E27	1	BR-BTWR 2,5/1R E28	1
Módulo relé		Referencia	Cant./Embal.	Referencia	Cant./Embal.	Referencia	Cant./Embal.
		RE-BTWR 4 C03	1	RE-BTWR 2,5R C03	1	RE-BTWR 2,5R C09	1
Tope final	Color	Referencia	Cant./Embal.	Referencia	Cant./Embal.	Referencia	Cant./Embal.
Paso 8 mm	Gris	PF3-BTW	100	PF3-BTW	100	PF3-BTW	100
	Gris	PF4-BTW	100	PF4-BTW	100	PF4-BTW	100
	Gris	PF5-BTW	100	PF5-BTW	100	PF5-BTW	100
Riel / Soporte	Tipo	Referencia	Cant./Embal.	Referencia	Cant./Embal.	Referencia	Cant./Embal.
DIN EN 50022	Riel	MR 35x7,5	Barras 2 m	MR 35x7,5	Barras 2 m	MR 35x7,5	Barras 2 m
	Soporte	ST-BTW	25	ST-BTW	25	ST-BTW	25
							
Identificador de grupo	Color	Referencia	Cant./Embal.	Referencia	Cant./Embal.	Referencia	Cant./Embal.
	Gris	IG-BTW	50	IG-BTW	50	IG-BTW	50
	Transp.	IG22-BTW ⁽¹⁾	25	IG22-BTW ⁽¹⁾	25	IG22-BTW ⁽¹⁾	25
Identificador²⁾		Referencia	Cant./Embal.	Referencia	Cant./Embal.	Referencia	Cant./Embal.
		IDB5-BTW	500	IDB5-BTW	500	IDB5-BTW	500
		IDG10/5-BTW	440	IDG10/5-BTW	440	IDG10/5-BTW	440
		IDG 10/6-BTW	360	IDG 10/6-BTW	360	IDG 10/6-BTW	360

Notas: 1) Para montaje sobre el tope final PF4-BTW.

2) Mayores detalles de los identificadores en la página 48.

Tabla de Selección - Relé de Interfaz

Línea BTWR - Relé de Interfaz

		BTWR P16E29 Paso 6,2 mm 				BTWR P16E31 Paso 6,2 mm 			
Datos técnicos		Tensión / Corriente / Sección nominal							
Tensión de la bobina		110 V ca/cc / 6 A				230 V ca/cc / 6 A			
Decapado del cable		8 mm				8 mm			
Par de apriete		0,4 Nm				0,4 Nm			
Corriente y tensión de operación		6 A 250 V ca / 30 V cc							
Máxima tensión de operación		400 V ca 3,7 A / 125 V cc 1,4 A)							
Máxima corriente de operación		6 A							
Máxima potencia de operación		1.500 VA / 180 W							
Vida mecánica		1x10 ⁷ operaciones							
Vida eléctrica		(NO) 3x10 ⁴ operaciones (85 °C) (NC) 1x10 ⁴ operaciones (85 °C)							
Resistencia de aislamiento		1.000 MΩ (500 V cc)							
Tiempo de operación		10ms máx.							
Señalización del relé		LED verde							
Capacidad de conexión									
Cable flexible		2,5 mm ²							
Material plástico	Color	Referencia	Cant./Embal.	Referencia	Cant./Embal.	Referencia	Cant./Embal.	Referencia	Cant./Embal.
Poliamida 66	Gris	BTWR P16E29	10	BTWR P16E31	10				
Puente conectora	Color	Referencia	Cant./Embal.	Referencia	Cant./Embal.	Referencia	Cant./Embal.	Referencia	Cant./Embal.
	Gris	PC-BTWR 2,5/16R	50	PC-BTWR 2,5/16R	50				
Base relé		Referencia	Cant./Embal.	Referencia	Cant./Embal.	Referencia	Cant./Embal.	Referencia	Cant./Embal.
		BR-BTWR 2,5/1R E29	1	BR-BTWR 2,5/1R E31	1				
Módulo relé		Referencia	Cant./Embal.	Referencia	Cant./Embal.	Referencia	Cant./Embal.	Referencia	Cant./Embal.
		RE-BTWR 2,5R C09	1	RE-BTWR 2,5R C09	1				
Tope final	Color	Referencia	Cant./Embal.	Referencia	Cant./Embal.	Referencia	Cant./Embal.	Referencia	Cant./Embal.
Paso 8 mm	Gris	PF3-BTW	100	PF3-BTW	100				
	Gris	PF4-BTW	100	PF4-BTW	100				
	Gris	PF5-BTW	100	PF5-BTW	100				
Riel / Soporte	Tipo	Referencia	Cant./Embal.	Referencia	Cant./Embal.	Referencia	Cant./Embal.	Referencia	Cant./Embal.
DIN EN 50022	Riel	MR 35x7,5	Barras 2 m	MR 35x7,5	Barras 2 m				
	Soporte	ST-BTW	25	ST-BTW	25				
									
Identificador de grupo	Color	Referencia	Cant./Embal.	Referencia	Cant./Embal.	Referencia	Cant./Embal.	Referencia	Cant./Embal.
	Gris	IG-BTW	50	IG-BTW	50				
	Transp.	IG22-BTW ¹⁾	25	IG22-BTW ¹⁾	25				
Identificador²⁾		Referencia	Cant./Embal.	Referencia	Cant./Embal.	Referencia	Cant./Embal.	Referencia	Cant./Embal.
		IDB5-BTW	500	IDB5-BTW	500				
		IDG10/5-BTW	440	IDG10/5-BTW	440				
		IDG 10/6-BTW	360	IDG 10/6-BTW	360				

Notas: 1) Para montaje sobre el tope final PF4-BTW.
2) Mayores detalles de los identificadores en la página 48.

Línea BTWR

Diagrama y Dimensiones

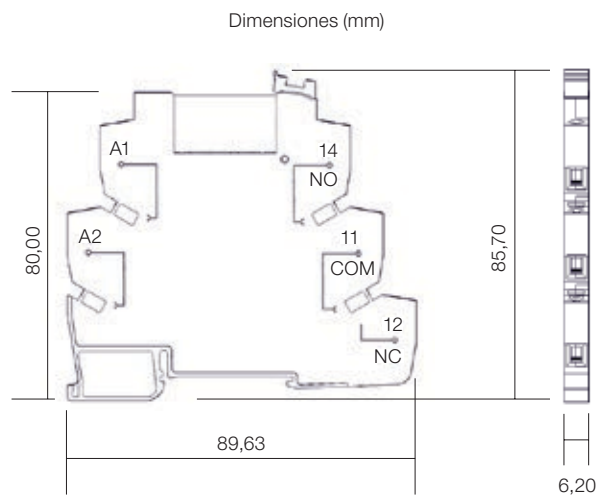
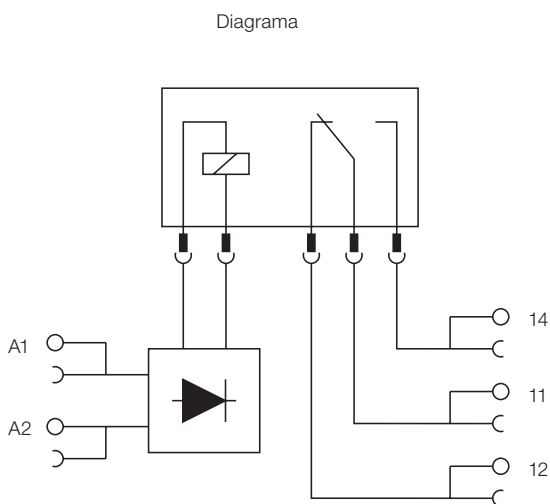

Línea BTWK/BTWY - Mini Bornes

Solución ideal para os proyectos con espacio limitado en tableros, cajas de unión y cajas de conexión de motores, como por ejemplo en fabricantes de máquinas de pequeño porte. Pueden ser montados en mini riel DIN 15x5 mm en superficie plana o placas de montaje.

Principales Ventajas de los Bornes da Línea BTWK / BTWY

- Cabos de sección transversal de 0,5 a 4 mm²
- Disponible en dos versiones de conexión:
 - Terminal tornillo
 - Terminal resorte
- Aplicación en ambientes con restricción de espacio
- Completa línea de accesorios
- Certificaciones CE y UL



BTWK



BTWY

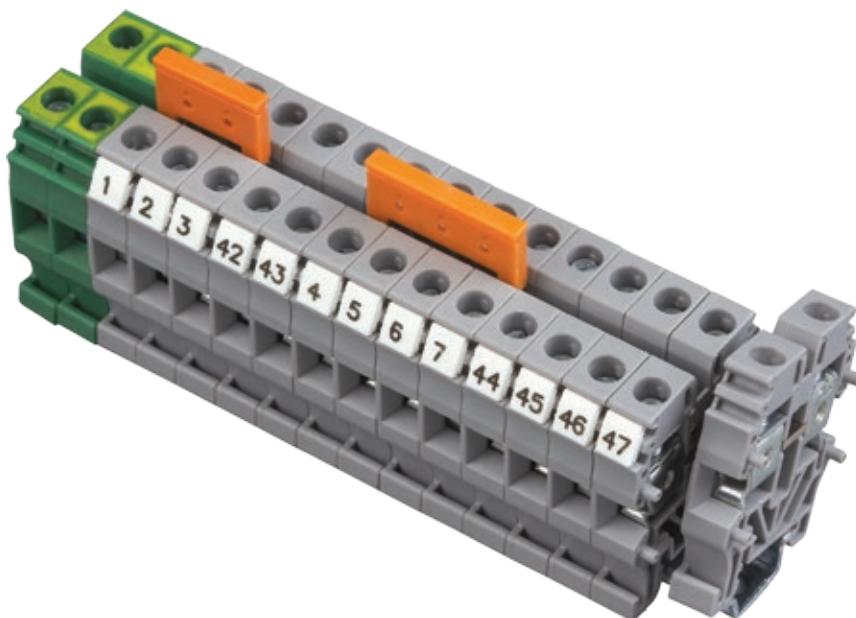



Opción de Montaje en Placa

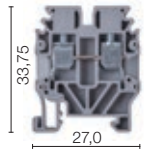
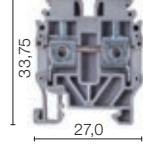
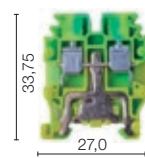
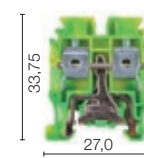
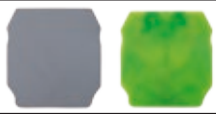

Tabla de Selección - Mini Bornes con Conexión Tipo Tornillo

Línea BTWK - Mini Bornes con Terminales Tipo Tornillo

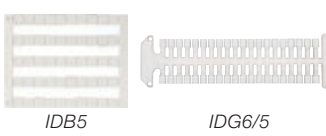
		BTWK 2,5 Paso 5 mm	CE	BTWK 4 Paso 6 mm	CE	BTWK 2,5T Paso 5 mm	CE	BTWK 4T Paso 6 mm	CE	
										
Datos técnicos		Tensión / Corriente / Sección nominal								
IEC 60947-7-1		400 V~ / 24 A / 2,5 mm ²		400 V~ / 32 A / 4 mm ²		2,5 mm ²		4 mm ²		
UL / CSA		300 V~ / 20 A / AWG 26 - 12		300 V~ / 30 A / AWG 24 - 10		AWG 26 - 12		AWG 24 - 10		
Decapado del cable		12 mm		10 mm		10 mm		10 mm		
Par de apriete		1,2 Nm		0,5 Nm		0,4 Nm		0,5 Nm		
Capacidad de conexión										
Hilo rígido		0,5 - 4 mm ²		0,5 - 6 mm ²		0,5 - 4 mm ²		0,5 - 6 mm ²		
Cable flexible		0,5 - 4 mm ²		0,5 - 6 mm ²		0,5 - 4 mm ²		0,5 - 6 mm ²		
Conductor AWG		16...8		26...10		26...12		26...10		
Material plástico	Color	Referencia	Cant./Embal.	Referencia	Cant./Embal.	Referencia	Cant./Embal.	Referencia	Cant./Embal.	
Poliamida 66	Gris	BTWK 2,5	100	BTWK 4	100	-	-	-	-	
	Verde	-	-	-	-	BTWK 2,5T	10	BTWK 4T	10	
Tapa terminal	Color	Referencia	Cant./Embal.	Referencia	Cant./Embal.	Referencia	Cant./Embal.	Referencia	Cant./Embal.	
	Gris	TF-BTWK 2,5-4	100	TF-BTWK 2,5-4	100	TF-BTWK 2,5-4T	100	TF-BTWK 2,5-4T	100	
Puente conectora	Nr. polos	Referencia	Cant./Embal.	Referencia	Cant./Embal.	Referencia	Cant./Embal.	Referencia	Cant./Embal.	
	2	PC-BTWM 2,5/2	25	PC-BTWM 4/2	25	PC-BTWM 2,5/2	25	PC-BTWM 4/2	25	
	3	PC-BTWM 2,5/3	20	PC-BTWM 4/3	20	PC-BTWM 2,5/3	20	PC-BTWM 4/3	20	
	4	PC-BTWM 2,5/4	15	PC-BTWM 4/4	15	PC-BTWM 2,5/4	15	PC-BTWM 4/4	15	
	10	PC-BTWM 2,5/10	5	PC-BTWM 4/10	5	PC-BTWM 2,5/10	5	PC-BTWM 4/10	5	
Tope final	Color	Referencia	Cant./Embal.	Referencia	Cant./Embal.	Referencia	Cant./Embal.	Referencia	Cant./Embal.	
	Gris	PF2-BTW-3	100	PF2-BTW-3	100	PF2-BTW-3	100	PF2-BTW-3	100	
Riel / Soporte	Tipo	Referencia	Cant./Embal.	Referencia	Cant./Embal.	Referencia	Cant./Embal.	Referencia	Cant./Embal.	
	DIN EN 50022	Riel	MR 15x5,5	Barras 1 m	MR 15x5,5	Barras 1 m	MR 15x5,5	Barras 1 m	MR 15x5,5	Barras 1 m
		Soporte	ST-BTW	25	ST-BTW	25	ST-BTW	25	ST-BTW	25
Identificador²⁾		Referencia	Cant./Embal.	Referencia	Cant./Embal.	Referencia	Cant./Embal.	Referencia	Cant./Embal.	
	IDB5	IDB5-BTW	500	IDB5-BTW	500	IDB5-BTW	500	IDB5-BTW	500	
	IDG6/5	IDG6/5-BTW	400	IDG6/5-BTW	400	IDG6/5-BTW	400	IDG6/5-BTW	400	



Notas: 1) Para montaje sobre el tope final PF4-BTW.

2) Mayores detalles de los identificadores en la página 48.

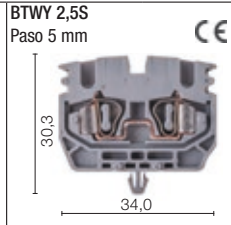
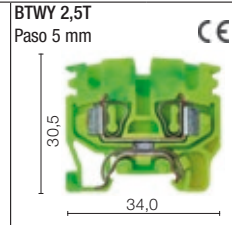
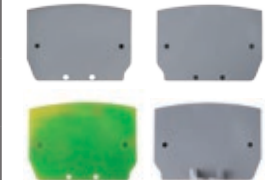

Tabla de Selección - Mini Bornes con Conexión Tipo Resorte

Línea BTWY - Mini Bornes con Terminales Tipo Resorte

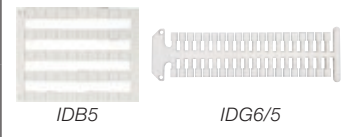
		BTWY 2,5 Paso 5 mm 	BTWY 2,5P Paso 5 mm 	BTWY 2,5S Paso 5 mm 	BTWY 2,5T Paso 5 mm 				
Datos técnicos		Tensión / Corriente / Sección nominal							
IEC 60947-7-1		750 V~ / 24 A / 2,5 mm ²	750 V~ / 24 A / 2,5 mm ²	750 V~ / 24 A / 2,5 mm ²	2,5 mm ²				
UL / CSA		600 V~ / 20 A / AWG 22 - 12	600 V~ / 20 A / AWG 22 - 12	600 V~ / 20 A / AWG 22 - 12	AWG 22 - 12				
Decapado del cable		10 mm	10 mm	10 mm	10 mm				
Capacidad de conexión									
Hilo rígido		0,5 - 4 mm ²	0,5 - 4 mm ²	0,5 - 4 mm ²	0,5 - 4 mm ²				
Cable flexible		0,5 - 2,5 mm ²	0,5 - 2,5 mm ²	0,5 - 2,5 mm ²	0,5 - 2,5 mm ²				
Conductor AWG		22...12	22...12	22...12	22...12				
Material plástico	Color	Referencia	Cant./Embal.	Referencia	Cant./Embal.	Referencia	Cant./Embal.	Referencia	Cant./Embal.
Poliamida 66	Gris	BTWY 2,5	50	BTWY 2,5P	100	BTWY 2,5S	100	-	-
	Verde	-	-	-	-	-	-	BTWY 2,5T	50
Tapa terminal	Color	Referencia	Cant./Embal.	Referencia	Cant./Embal.	Referencia	Cant./Embal.	Referencia	Cant./Embal.
	Gris	TF-BTWY	100	TFF-BTWY 2,5E ³⁾	100	TF-BTWY 2,5E ³⁾	100	-	-
	Verde	-	-	TFF-BTWY 2,5D ³⁾	100	TF-BTWY 2,5D ³⁾	100	-	-
	Verde	-	-	-	-	-	-	TF-BTWY 2,5T	10
Puente conectora	Nr. polos	Referencia	Cant./Embal.	Referencia	Cant./Embal.	Referencia	Cant./Embal.	Referencia	Cant./Embal.
	2	PC-BTWM 2,5/2	25	PC-BTWM 2,5/2	25	PC-BTWM 2,5/2	25	PC-BTWM 2,5/2	25
	3	PC-BTWM 2,5/3	20	PC-BTWM 2,5/3	20	PC-BTWM 2,5/3	20	PC-BTWM 2,5/3	20
	4	PC-BTWM 2,5/4	15	PC-BTWM 2,5/4	15	PC-BTWM 2,5/4	15	PC-BTWM 2,5/4	15
	10	PC-BTWM 2,5/10	5	PC-BTWM 2,5/10	5	PC-BTWM 2,5/10	5	PC-BTWM 2,5/10	5
Tope final	Color	Referencia	Cant./Embal.	Referencia	Cant./Embal.	Referencia	Cant./Embal.	Referencia	Cant./Embal.
	Gris	PF2-BTW-3	100	Incorporado		Incorporado		PF2-BTW-3	100
Riel / Soporte	Tipo	Referencia	Cant./Embal.	Referencia	Cant./Embal.	Referencia	Cant./Embal.	Referencia	Cant./Embal.
	Riel	MR 15x5,5	Barras 1 m	Montaje en placa		Montaje en placa		MR 15x5,5	Barras 1 m
	Soporte	ST-BTW	25					ST-BTW	25
Identificador²⁾		Referencia	Cant./Embal.	Referencia	Cant./Embal.	Referencia	Cant./Embal.	Referencia	Cant./Embal.
	IDB5	IDB5-BTW	500	IDB5-BTW	500	IDB5-BTW	500	IDB5-BTW	500
	IDG6/5	IDG6/5-BTW	400	IDG6/5-BTW	400	IDG6/5-BTW	400	IDG6/5-BTW	400

Notas: 1) Para montaje sobre el tope final PF4-BTW.

2) Mayores detalles de los identificadores en la página 48.

3) Los bornes TF-BTWY 2,5E y TFF-BTWY 2,5E necesitan de tapas finales del lado izquierdo del borne. Los bornes TF-BTWY 2,5D y TFF-BTWY 2,5D necesitan de tapas finales del lado derecho del borne.

Conectores de Barras

Línea CB

Línea CB conectores de barra		CB4		CB10		CB35	
							
Datos técnicos							
Sección nominal		4 mm ²		10 mm ²		35 mm ²	
Tornillo		M3		M4		M6	
Dimensiones de la barra		10x3 mm		10x3 mm		10x3 mm	
Decapado del cable		16 mm		19 mm		19 mm	
Par de apriete		0,5 Nm		1,2 Nm		2,8 Nm	
Capacidad de conexión							
Hilo rígido		0,5...6 mm ²		1,5...10 mm ²		16...50 mm ²	
Cable flexible		0,5...4 mm ²		2,5...10 mm ²		16...35 mm ²	
Color		Referencia	Cant./Embal.	Referencia	Cant./Embal.	Referencia	Cant./Embal.
-		CB4-BTW	200	CB10-BTW	100	CB35-BTW	50
Azul		CB4N-BTW	100	CB10N-BTW	100	CB35N-BTW	50
Verde/amarillo		CB4PE-BTW	100	CB10PE-BTW	100	CB35PE-BTW	50
SopORTE de barra	Color	Referencia	Cant./Embal.	Referencia	Cant./Embal.	Referencia	Cant./Embal.
	Beige	SB-BTW ¹⁾	50	SB-BTW ¹⁾	50	SB-BTW ¹⁾	50
SopORTE de barra / Tope final	Color	Referencia	Cant./Embal.	Referencia	Cant./Embal.	Referencia	Cant./Embal.
	Gris	PF5-BTW ²⁾	100	PF5-BTW ²⁾	100	PF5-BTW ²⁾	100
Tapa de protección ³⁾	Color	Referencia	Cant./Embal.	Referencia	Cant./Embal.	Referencia	Cant./Embal.
	Transp.	TT-BTW	1 m x 10	TT-BTW	1 m x 10	TT-BTW	1 m x 10
SopORTE de enclave (PF5-BTW + TT-BTW)	Color	Referencia	Cant./Embal.	Referencia	Cant./Embal.	Referencia	Cant./Embal.
	Naranja	PF5-BTW PE	4	PF5-BTW PE	4	PF5-BTW PE	4
SopORTE de tapa de protección	Color	Referencia	Cant./Embal.	Referencia	Cant./Embal.	Referencia	Cant./Embal.
	Gris	STT-BTW	2	STT-BTW	2	STT-BTW	2
Barra de cobre estañada 10x3 mm		Referencia	Cant./Embal.	Referencia	Cant./Embal.	Referencia	Cant./Embal.
		BR10x3	Barras 1 m	BR10x3	Barras 1 m	BR10x3	Barras 1 m

Notas: 1) Acomoda también barras de las siguientes dimensiones: 15x2 mm, 15x3 mm, 12x2 mm y 6x6 mm.

2) Es posible el montaje de hasta 3 barras de 10x3 mm en el tope final PF5-BTW.

3) La Tapa de protección TT-BTW puede ser armada en: PF5-BTW + PF5-BTW PE o solamente con STT-BTW.



Imagen solamente ilustrativa.

El montaje indica la posibilidad de utilización de las barras para circuitos de distribución.

Sistemas de Impresión PWA3 & PWA4

PWA3 y PWA4 son sistemas de impresión de identificadores más flexibles para aplicaciones industriales posibilitando grabar todos los materiales de identificación como conjunto de identificadores de bornes, placas autoadhesivas para identificación de tableros y placas identificadoras de cables a través del uso de una bandeja de impresión. El control es hecho por el software de manera clara y rápida, este puede ser conectado con una computadora por medio de la interfaz USB. La operación es posible con pocas teclas, haciendo de la grabación una operación muy sencilla.

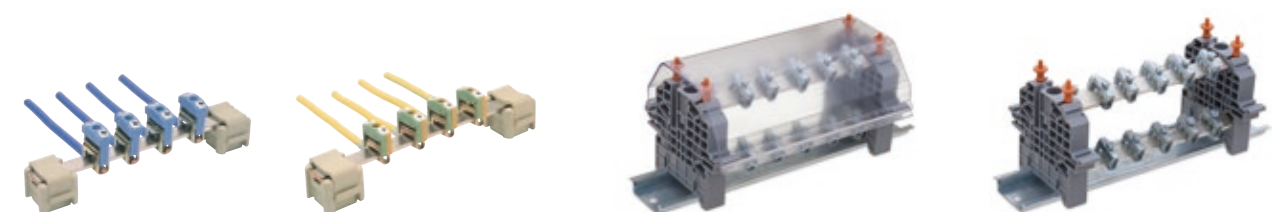
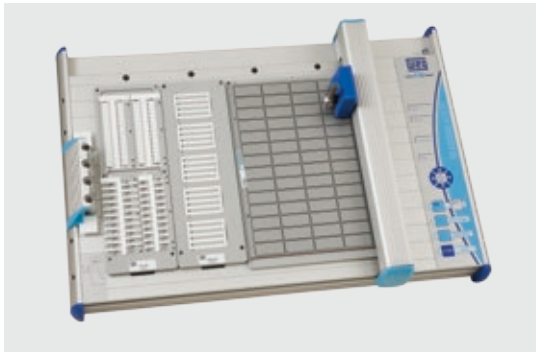

Ítems Inclucos con el Plotter PWA3

- Dos bandejas de soporte para identificadores de bornes IDG-BTW / IDB5-BTW
- Dos bolígrafos para plotter 0,25 mm C025-PW
- Un conjunto con cinco repuestos de tinta para bolígrafo plotter (5x1 ml) CT-PW
- Un bolígrafo permanente (prueba) 0,30 mm CP030-PW
- Un repuesto de tinta plotter 30 ml RT-PW
- Un conjunto limpieza KL-PW
- Una capa de protección plotter CP-PW
- Conjunto de plaquetas para limpieza de bolígrafos con 25 piezas

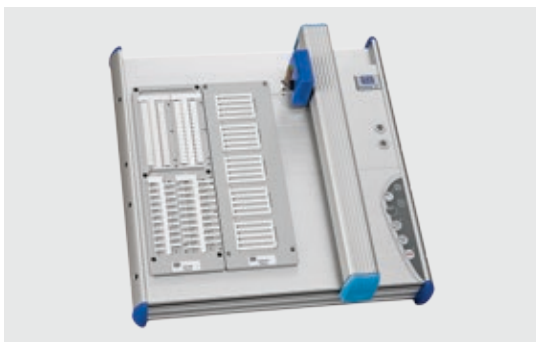

Ítems Inclucos con el Plotter PWA4

- Dos bandejas de soporte para identificadores de bornes IDG-BTW / IDB5-BTW
- Dos bolígrafos para plotter 0,25 mm C025-PW
- Conjunto de plaquetas para limpieza de bolígrafos con 25 piezas

Accesorios para el Sistema de Impresión PWA3 y PWEA4

WEG posee una línea completa de repuestos para los sistemas de impresión PWA3 y PWEA4.

Descripción	Cantidad	Referencia
Repuesto de tinta plotter 30 ml	1	RT2-PW
Repuesto de tinta plotter 5x1 ml	1	CT2-PW
Repuesto de tinta plotter 30 ml	1	RT-PW
Repuesto de tinta plotter 5x1 ml	5	CT-PW
Fluido de limpieza 1x30 ml	1	FL-PW
Bolígrafo plotter descartable 0,18 mm	1	C018-PD
Bolígrafo plotter descartable 0,25 mm	1	C025-PD
Bolígrafo plotter descartable 0,35 mm	1	C035-PD
Bolígrafo plotter descartable 0,50 mm	1	C050-PD
Bolígrafo plotter descartable 0,70 mm	1	C070-PD
Bolígrafo plotter descartable 1,00 mm	1	C100-PD
Bolígrafo plotter recargable 0,18 mm	1	C018-PW
Bolígrafo plotter recargable 0,25 mm	1	C025-PW
Bolígrafo plotter recargable 0,35 mm	1	C035-PW
Bolígrafo plotter recargable 0,50 mm	1	C050-PW
Bolígrafo plotter recargable 0,70 mm	1	C070-PW
Bolígrafo plotter recargable 1,00 m	1	C100-PW
Bolígrafo permanente (teste) 0,30 mm	1	CP030-PW
Kit limpieza	1	KL-PW
Bandeja de impresión para identificadores	1	IDG-PW
Bandeja de impresión para identificadores	1	IDB5-PW
Bandeja de impresión para plaquetas	1	KLM-PW
Aparato de succión	1	BS-PW
Soporte de bolígrafo - plotter	1	CPC-PW

Sistema de Grabación Fresadora PWEA4

El Sistema PWEA4 graba en superficies multicamadas plásticas, latón, aluminio y diversos materiales. La grabación es controlada a través del software WEG de forma rápida y sencilla.

WEG también suministra el kit PWE que puede ser conectado en el sistema de impresión PWA3/PWA4 transformando en un sistema de grabación PWEA4.

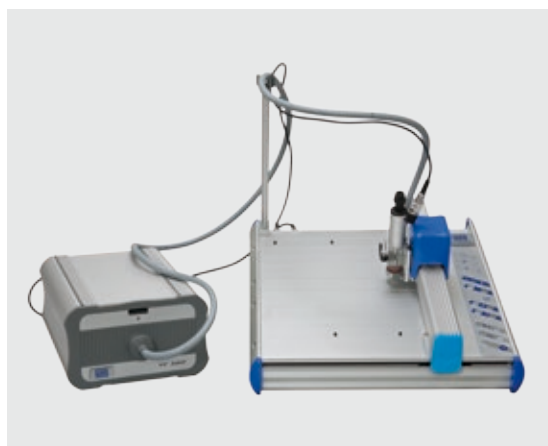

Ítems Incorporados con el Sistema de Grabación PWEA4

- Cable USB
- Cabezal fresa
- Soporte para cables y mangueras de succión
- Fresa plotter EN15-50 0,50 mm

Ítems Incorporados con el Cabezal Sistema de Grabación PWE

- Cable USB
- Cabezal fresa
- Soporte para cables y mangueras de succión
- Fresa plotter EN15-50 0,50 mm
- Soporte para cabezal fresa
- Controlador CNC
- Aspiradora de polvo
- Placa de calibración para alineamiento

Accesorios para el Sistema de Impresión PWEA4

Descripción	Cantidad	Referencia
Aspiradora	1	VC-PWEA4
Bolsa de aspiradora	1	VCB-PWEA4
Fresa plotter punta sencilla 15 grados 0,20 mm	1	EN15-20
Fresa plotter punta sencilla 15 grados 0,30 mm	1	EN15-30
Fresa plotter punta sencilla 15 grados 0,40 mm	1	EN15-40
Fresa plotter punta sencilla 15 grados 0,50 mm	1	EN15-50
Fresa plotter punta sencilla 15 grados 0,70 mm	1	EN15-70
Fresa plotter punta sencilla 15 grados 1,00 mm	1	EN15-100
Kit de fresa plotter 15 grados	1	EN15-SET
Fresa plotter punta doble y ancho de 0,50 mm	1	FT-50
Fresa plotter punta doble y ancho de 0,60 mm	1	FT-60
Fresa plotter punta doble y ancho de 0,80 mm	1	FT-80
Fresa plotter punta doble y ancho de 1,00 mm	1	FT-100
Fresa plotter punta doble y ancho de 1,20 mm	1	FT-120
Fresa plotter punta doble y ancho de 1,40 mm	1	FT-140
Fresa plotter punta doble y ancho de 1,60 mm	1	FT-160
Fresa plotter punta doble y ancho de 2,00 mm	1	FT-200
Fresa plotter punta doble y ancho de 2,40 mm	1	FT-240
Fresa plotter punta doble y ancho de 3,00 mm	1	FT-300

Identificadores

Conjunto de Identificadores de Conductores KIP/KBEP

La identificación clara de todos los conductores y cables contribuyen mucho para una mejor visualización y mantenimiento en tableros y instalaciones. La identificación de conductores es permanente y de alta calidad.

Suministramos los siguientes ítems para identificación de los conductores:

- Conjunto de identificación para conductores con dimensión 15x4 mm (ref. KIP 15 W / caja con 480 piezas)
- Disponible en los colores blanco y amarillo



- Conjunto de identificación para conductores con dimensión 18x4 mm (ref. KIP 18 W / caja con 240 piezas)
- Disponible en los colores blanco y amarillo



- Conjunto de identificación para conductores con dimensión 23x4 mm (ref. KIP 23 W / caja con 240 piezas)
- Disponible en los colores blanco y amarillo



- Conjunto de identificación para conductores con dimensión 30x4 mm (ref. KIP 30 W / caja con 240 piezas)
- Disponible en los colores blanco y amarillo







- Conjunto de identificación para conductores con dimensión 20x9 mm (ref. KBEP209W / caja con 240 piezas)
- Disponible en color blanco



Identificadores

Identificadores para Bornes

Identificadores	IDB5	IDG6/5	IDG10/5	IDG10/6
				
Datos técnicos				
Identificador dimensiones (largo x ancho)	5x5 mm	6x5 mm	10x5 mm	10x6 mm
Color del Identificador	Blanco	Blanco	Blanco	Blanco
Color de la inscripción	Negro	Negro	Negro	Negro
Numero of Identificadores por caja	500	400	440	360
Grabación				
Sin grabación	Referencia			
Código alfa numérico bajo consulta	IDB5-BTW	IDG6/5-BTW	IDG10/5T-BTW	IDG10/6T-BTW

Notas: - Los identificadores son suministrados solamente en cartelas.
 - Inscripciones bajo consulta.
 - Suministrado en cajas.

Fundas Transparentes para Identificadores de Cables KKS/KBE

Estos sistemas de identificación de cables son compuestos de fundas y placas identificadoras. Las fundas KKS están disponibles para cables desde 0,5 hasta 25 mm de diámetro. Para cables mayores que 20 mm² use identificadores KBE-3 fijados con cinta plastica.



Modelos Disponibles

Diámetro del cable		Largo de la funda	Embalaje (piezas)	Referencia
mm ²	AWG			
0,5...1,5	20...16	15 mm	2000	KKS 15/0,5-1,5
0,5...1,5	20...16	18 mm	2000	KKS 18/0,5-1,5
0,5...2,5	20...16	23 mm	2000	KKS 23/0,5-2,5
0,5...1,5	20...16	30 mm	1200	KKS 30/0,5-1,5
1,5...2,5	16...14	15 mm	500	KKS 15/1,5-2,5
1,5...2,5	16...14	18 mm	500	KKS18/1,5-2,5
1,5...2,5	16...14	23 mm	500	KKS 23/1,5-2,5
1,5...2,5	16...14	30 mm	500	KKS 30/1,5-2,5
2,5...4	14...12	15 mm	500	KKS 15/2,5-4
2,5...4	14...12	18 mm	500	KKS18/2,5-4
2,5...4	14...12	23 mm	500	KKS 23/2,5-4
2,5...4	14...12	30 mm	500	KKS 30/2,5-4
6...10	10...8	15 mm	500	KKS 15/6-10
6...10	10...8	18 mm	500	KKS18/6-10
6...10	10...8	23 mm	500	KKS 23/6-10
6...10	10...8	30 mm	200	KKS 30/6-10
16...25	6...4	15 mm	500	KKS 15/16-25
16...25	6...4	18 mm	500	KKS18/16-25
16...25	6...4	23 mm	200	KKS 23/16-25
16...25	6...4	30 mm	200	KKS 30/16-25
> 20	> 4	20 mm	120	KBE-3

Identificadores

Conjunto de Placas Autoadhesivas KLM

La identificación de los componentes eléctricos y en los tableros de comando es requisito previo para un trabajo rápido y objetivo. WEG ofrece placas autoadhesivas de excelente calidad en distintos tamaños. Este tipo de identificación es económica y se caracteriza por una gran resistencia. Actualmente WEG suministra nueve tamaños distintos de placas autoadhesivas, de acuerdo con las informaciones abajo:



- Conjunto de placas autoadhesivas 27x12,5 mm con 120 placas (ref. KLM 27x12,5)



- Conjunto de placas autoadhesivas 45x14 mm con 80 placas (ref. KLM 45x14)

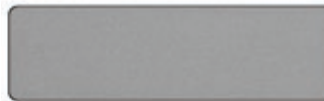

- Conjunto de placas autoadhesivas 45x19 mm con 56 placas (ref. KLM 45x19)



- Conjunto de placas autoadhesivas 27x18 mm con 90 placas (ref. KLM 27x18)



- Conjunto de placas autoadhesivas 70x35 mm con 20 placas (ref. KLM 70x35)



- Conjunto de placas autoadhesivas 120x35 mm con 10 placas (ref. KLM 120x35)

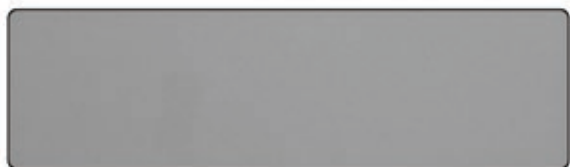

- Conjunto de placas autoadhesivas 20x8 mm con 306 placas (ref. KLM 20x8)



- Conjunto de placas autoadhesivas 60x30 mm con 24 placas (ref. KLM 60x30)

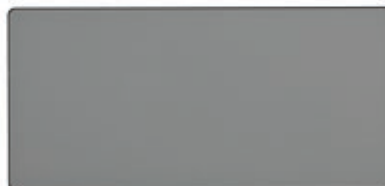

- Conjunto de placas autoadhesivas 52x26 mm con 35 placas (ref. KLM 52x26)



Sucursales WEG en el Mundo

ALEMANIA

Türnich - Kerpen
Teléfono: +49 2237 92910
info-de@weg.net

Balingen - Baden-Württemberg
Teléfono: +49 7433 90410
info@weg-antriebe.de

ARGENTINA

San Francisco - Córdoba
Teléfono: +54 3564 421484
info-ar@weg.net

Córdoba - Córdoba
Teléfono: +54 351 4641366
weg-morbe@weg.com.ar

Buenos Aires
Teléfono: +54 11 42998000
ventas@pulverlux.com.ar

AUSTRALIA

Scoresby - Victoria
Teléfono: +61 3 97654600
info-au@weg.net

AUSTRIA

Markt Piesting - Wiener
Neustadt-Land
Teléfono: +43 2633 4040
watt@wattdrive.com

BÉLGICA

Nivelles - Bélgica
Teléfono: +32 67 888420
info-be@weg.net

BRASIL

Jaraguá do Sul - Santa Catarina
Teléfono: +55 47 32764000
info-br@weg.net

CHILE

La Reina - Santiago
Teléfono: +56 2 27848900
info-cl@weg.net

CHINA

Nantong - Jiangsu
Teléfono: +86 513 85989333
info-cn@weg.net

Changzhou - Jiangsu
Teléfono: +86 519 88067692
info-cn@weg.net

COLOMBIA

San Cayetano - Bogotá
Teléfono: +57 1 4160166
info-co@weg.net

ECUADOR

El Batán - Quito
Teléfono: +593 2 5144339
ceccato@weg.net

EMIRATOS ARABES UNIDOS

Jebel Ali - Dubai
Teléfono: +971 4 8130800
info-ae@weg.net

ESPAÑA

Coslada - Madrid
Teléfono: +34 91 6553008
wegiberia@wegiberia.es

EEUU

Duluth - Georgia
Teléfono: +1 678 2492000
info-us@weg.net

Minneapolis - Minnesota
Teléfono: +1 612 3788000

FRANCIA

Saint-Quentin-Fallavier - Isère
Teléfono: +33 4 74991135
info-fr@weg.net

GHANA

Accra
Teléfono: +233 30 2766490
info@zestghana.com.gh

INDIA

Bangalore - Karnataka
Teléfono: +91 80 41282007
info-in@weg.net

Hosur - Tamil Nadu
Teléfono: +91 4344 301577
info-in@weg.net

ITALIA

Cinisello Balsamo - Milano
Teléfono: +39 2 61293535
info-it@weg.net

JAPON

Yokohama - Kanagawa
Teléfono: +81 45 5503030
info-jp@weg.net

MALASIA

Shah Alam - Selangor
Teléfono: +60 3 78591626
info@wattdrive.com.my

MEXICO

Huehuetoca - Mexico
Teléfono: +52 55 53214275
info-mx@weg.net

Tizayuca - Hidalgo
Teléfono: +52 77 97963790

PAISES BAJOS

Oldenzaal - Overijssel
Teléfono: +31 541 571080
info-nl@weg.net

PERU

La Victoria - Lima
Teléfono: +51 1 2097600
info-pe@weg.net

PORTUGAL

Maia - Porto
Teléfono: +351 22 9477700
info-pt@weg.net

RUSIA y CEI

Saint Petersburg
Teléfono: +7 812 363 2172
sales-wes@weg.net

SINGAPOR

Singapor
Teléfono: +65 68589081
info-sg@weg.net

Singapor
Teléfono: +65 68622220
watteuro@watteuro.com.sg

SUDAFRICA

Johannesburg
Teléfono: +27 11 7236000
info@zest.co.za

SUECIA

Mölnlycke - Suecia
Teléfono: +46 31 888000
info-se@weg.net

REINO UNIDO

Redditch - Worcestershire
Teléfono: +44 1527 513800
info-uk@weg.net

VENEZUELA

Valencia - Carabobo
Teléfono: +58 241 8210582
info-ve@weg.net

Para los países donde no hay una operación WEG, encuentre el distribuidor local en www.weg.net.



Grupo WEG - Unidad Automatización
Jaraguá do Sul - SC - Brasil
Teléfono: +55 (47) 3276-4000
automacao@weg.net
www.weg.net

