

# MVW01

## Medium Voltage Variable Speed Drive

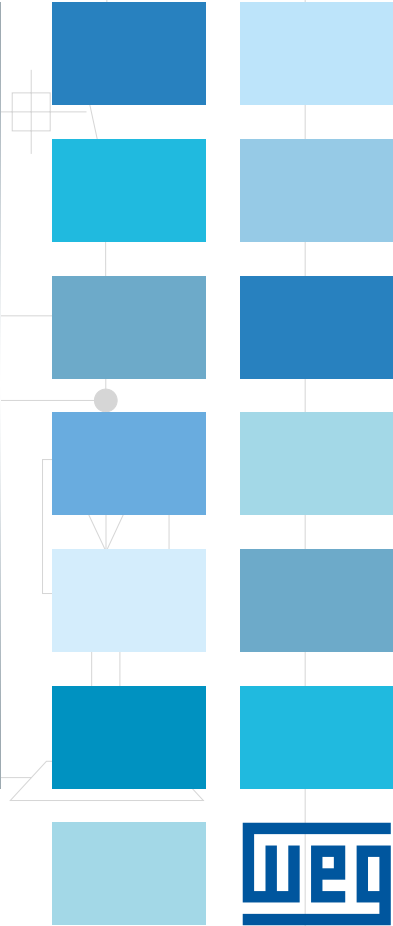
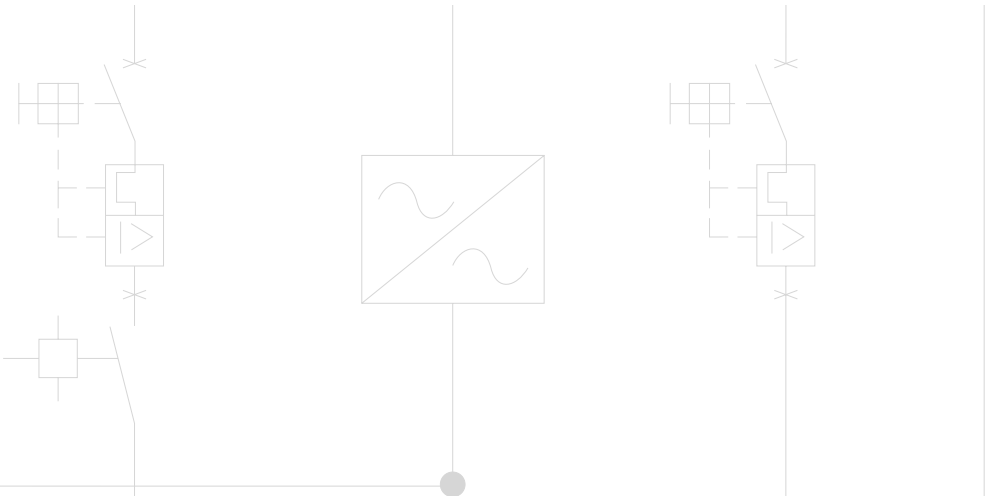

3

3







# Medium Voltage Variable Speed Drive - MVW01

## Summary

MV Components for a MV VSD	07
MVW01 Main Product Features	10
MVW01 Models	12
MVW01 Compact Integrated VSD	14
MVWCi/MVWMi Integrated VSD	15
Interfaces	16
MVW01 Main Features	20
MVW System Customized Solutions	22
Specification Table	23
MVW01 VSD Panel Dimensions	24
Product Code	25
General Technical Characteristics	26



# WEG MVW01 Variable Speed Drive (VSD)

## Efficient, Reliable, Safe Motor Control for a Wide Range of Industrial Applications

**WEG introduces** second generation of Medium Voltage Variable Speed Drives **MVW01 G2**. Second Generation **MVW01 delivers higher power output and higher reliability** on existing footprint. Higher performance is achieved by the use of latest **HV IGBTs with larger safe operating area** and higher short circuit capability.

Friendly operator interface, identical to that of Low Voltage VSD product line, presents familiarity and ease of use.

MVW G2 is perfectly suitable for a variety of variable speed industrial applications such as compressors, pumps, fans, conveyors and grinding mills.

For new installations or revamps, MVW01 G2 offers robust solutions to optimize your process and save significantly on operating costs.





- Efficiency
- Reliability
- Safety

### Features

- Voltage Source Inverter (VSI) featuring NPC topology
- Latest generation power components including 6.5 kV IGBTs
- Optimum number of power and control components resulting into the highest efficiency design on the market
- High power factor over entire speed range
- Power: 500 to 22,500 HP (400 to 16,000 kW)
- Voltage: 2.3 kV to 6.9 kV
- Output frequency: up to 120 Hz

### Certifications



# Offering Solutions to a Wide Variety of Industrial Segments

## Key Industry Sectors for Medium-Voltage Drives

<b>Petrochemicals</b>  Downhole pumps, pipeline pumps, gas compressors, water injection pumps, blowers	<b>Pulp &amp; Paper</b>  Fans and pumps, grinders, chippers, yankee blowers, winders, refiners	<b>Power generation</b>  Forced draft and induced draft fans, boiler feed pumps, recirculating pumps
<b>Mining</b>  Slurry pumps, conveyors, crushers and mills	<b>Cement</b>  Kiln and baghouse fans, cooler exhaust, forced draft and induced draft fans, crushers and mills	<b>Metals</b>  Descaling pumps, cooling pumps and fans
<b>Water/ Waste</b>  Fresh water pumps, sewage and effluent pumps	<b>Chemicals</b>  Pumps, compressors, extruders	<b>Marine</b>  Propulsion, thrusters, off-load pumps
<b>Plastic &amp; Rubber</b>  Banbury mixers	<b>Infrastructure</b>  Pumps, compressors	<b>Sugar &amp; Ethanol</b>  Sugarcane mills, fans, blowers, centrifuges





# MV Components for a MV VSD

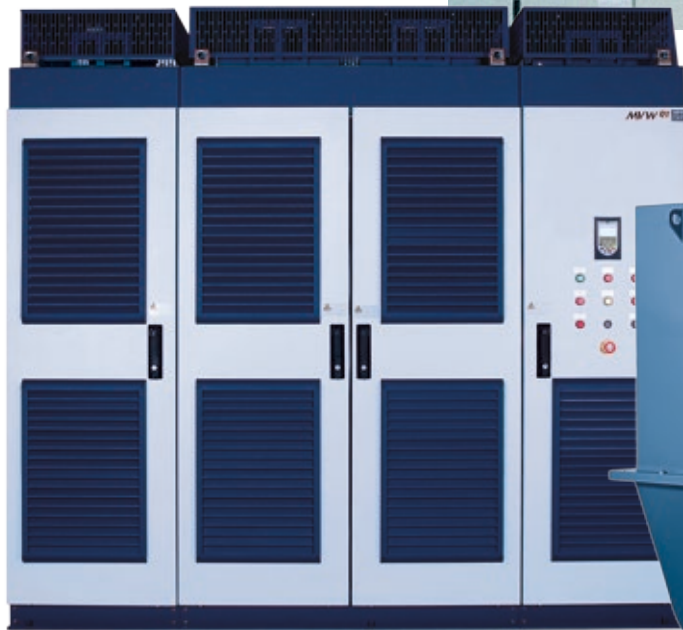

Topology with minimum number of power and control components equals to reliability and efficiency.

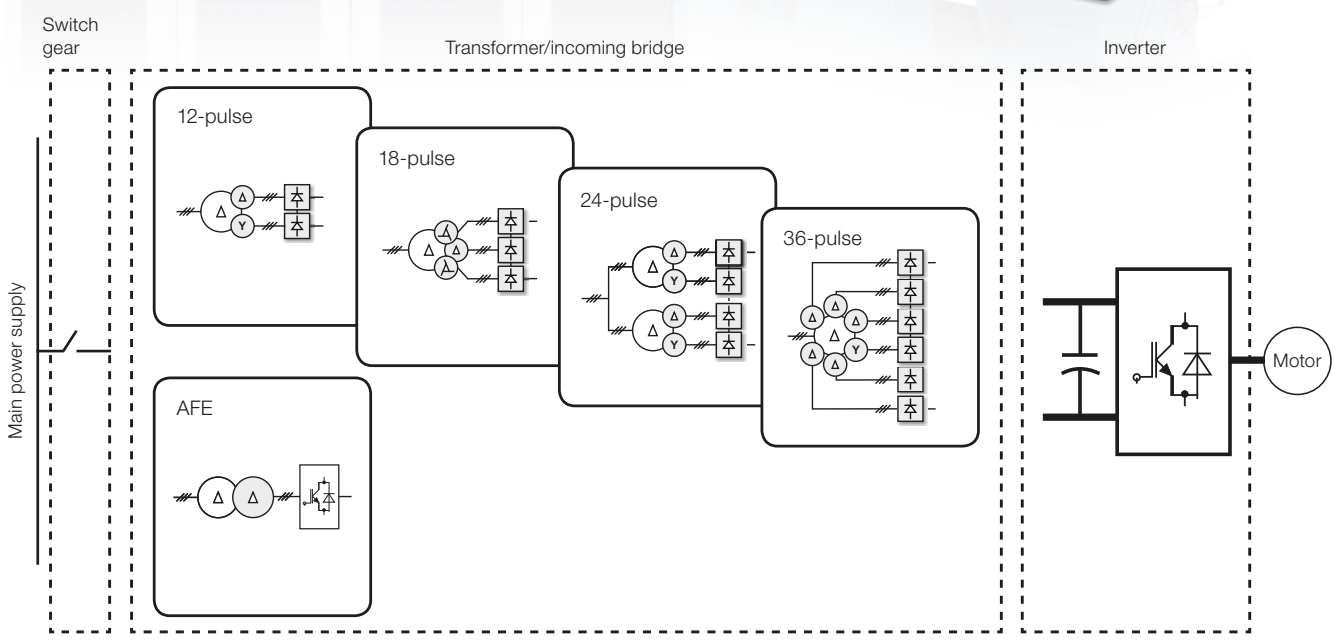

- Voltage Source Inverter (VSI) technology with Neutral Point Clamp (NPC) multilevel power topology featuring optimum number of power components with HV 6.5 kV IGBTs
- Phase shifting transformer: 12-, 18-, 24-, 36-Pulse
- Option to active front end (4 Q)
- Optimum synchronous PWM control (OPP™) to minimize current harmonics in the motor circuit
- Long life plastic film capacitors for DC link voltage source (no electrolytic capacitors)
- DC link voltage balance using transistor (IGBT) switching states
- Floating DC link circuit to minimize voltage stress on motor insulation
- Arc sensor for each power module for self protection
- Fuseless design for improved reliability
- Draw-out style power modules with stab power connections that eliminates connecting or disconnecting of power cables for easy and fast servicing

# WEG provides the **COMPLETE SOLUTION**



## Nine Good Reasons Why you Should Consider WEG for your Complete MV VSD System Solution

- 1 - WEG team delivers an aptly engineered and manufactured VSD system that provides the best solution, while its customers are free to pursue bigger business opportunities
- 2 - VSDs are built with standard safety features such as mechanical interlocking (kirk key), line of sight protection for louvered filter covers and arc flash detection via light sensors
- 3 - Motor friendly output waveform limits dv/dt, peak voltage levels, current harmonics and with choice of output filters allows use of existing motors with older insulation system, maintaining motor longevity
- 4 - Phase shifting transformer can be installed outside electrical room to save significantly on HVAC equipment and its maintenance costs
- 5 - License free PC based software is available for download for paperless recording of parameters and events
- 6 - Complete system testing including Switchgear, Transformer, VSD and Motor under full load conditions using dynamometer at largest motors & drives facility in South America
- 7 - Factory specialists can provide customers total assistance with quick response time when necessary and actively provide support via authorized service centers
- 8 - Quality Control: ISO 9001 and ISO 14000 certified factory with strict QA procedures mandate functional tests for all control boards and two hour load testing for each VSD shipped
- 9 - WEG R&D team dedicated exclusively for the MV VSD, helps in developing state of the art hardware and software functions







#### Input Switchgear

- System input protection
- Mechanically and electrically interlocked with VSD
- Metal clad switchgear with CB or metal enclosed with disconnect switch + vacuum contactor + MV fuses
- Opens under VSD command in less than 100ms
- Existing switchgear can also be used with basic open/close/trip signals and feedback

#### Phase Shifting Transformer

- Provides complete system isolation for common-mode voltage stress mitigation on the motor
- Natural harmonic reduction on the power supply
- Fault current limitation
- Voltage matching
- Flexibility of installation with dry type or oil type
- Installation can be indoor or outdoor
- Isolates the system from supply side grounding and in case of ground fault, VSD generates alarm while keeping motor operation under control or can be programmed for safe trip

#### MVW01 MV VSD

- Latest generation of 6.5 kV power transistors (IGBTs)
- Modular rectifier section: 12P, 18P, 24P or 36P rectifier
- Long life plastic film capacitors for DC link voltage
- Optimum synchronous PWM control (OPP) to minimize voltage harmonics in the motor circuit
- Draw-out style power modules
- Optimized for inverter duty motors
- Customized with optional filters for standard motors

#### WEG MV Motor

- Synchronous or induction motor control
- Standard motor voltages: 2.3 kV, 3.3 kV, 4.16 kV, 5.5 kV, 6.6 kV, 6.9 kV
- System optimization with inverter duty motors
- Possibility of working with non inverter duty motors or old motors (retrofitting)





## MVW01 Main Product Features



### Input: 12-, 18-, 24-, 36-Pulse Rectifier Bridge or AFE (Active Front End) Option

- High power factor (>0.95)
- High power quality
- IEEE 519 compliance



### Air-Cooling

- Redundant fans
- Low heat dissipation
- Low noise level
- No maintenance hassel of water cooled systems



### Cable Connections

- Standard product available with both top entry/top exit or bottom entry/bottom exit for power/control cables

### Power Arms

- Latest generation of power semiconductors and capacitors
- Simple control connection with fiber optics
- Draw-out style power modules with stab power connections that eliminates connecting or disconnecting of power cables allowing easy and fast servicing

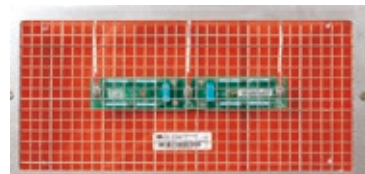

### DC Link Voltage Monitoring

- Visual indication of presence of voltage on the DC link for additional personnel safety



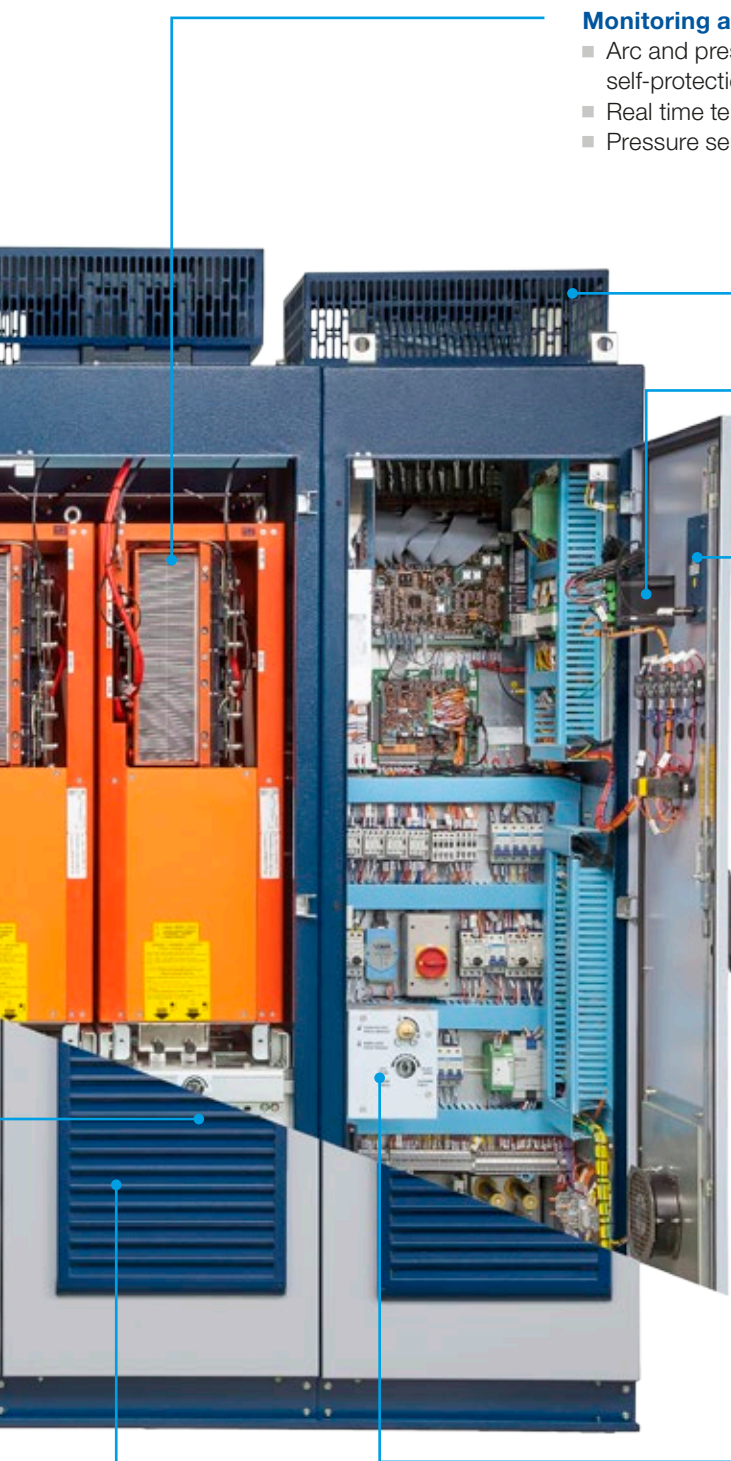

### Monitoring and Protections

- Arc and pressure sensors for special self-protection
- Real time temperature monitoring
- Pressure sensors for cooling monitoring

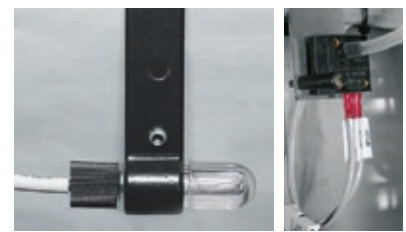

### Thermal Protection

- Pt-100 individual monitoring for motor thermal protection (bearings and windings)



### Fiber Optic Interface

- Noise immunity
- Isolation between the control and power section
- Gate drivers, temperature monitoring, feedbacks, etc.



### Standard HMI (Keypad)

- Graphic display
- Full operation, navigation, programming and monitoring
- Complete parameters instructions and fault descriptions
- Numerical and/or bars display

### Air Inlet Filters

- Washable and replaceable from the front without disturbing the normal operation



### Mechanical Lock Safety

- Safety operation with mechanical lock for the power sections
- Electro-mechanical interlocking with the main input breaker to prevent access to MV section when the main breaker is closed

## MVW01 Models

### MVW01 G2 - Standard VSD - 3,300 V & 4,160 V

Product	Rated current			Motor		Frame size	Rect. pulses
	Mx	ND	HD	ND	HD		
	A			HP			
<b>3,300 V</b>							
MVW01 C096 T3300 EH30G2Z	98	96	85	600	500	A0	18
MVW01 C113 T3300 EH30G2Z	116	113	99	700	600		
MVW01 C131 T3300 EH30G2Z	134	131	115	800	750		
MVW01 C152 T3300 EH30G2Z	155	152	134	900	800		
MVW01 C176 T3300 EH30G2Z	180	176	155	1,100	900		
MVW01 0204 T3300 EH20G2Z	214	204	180	1,250	1,100	A	12
MVW01 0237 T3300 EH20G2Z	249	237	208	1,500	1,350		
MVW01 0276 T3300 EH20G2Z	290	276	242	1,750	1,500		
MVW01 0322 T3300 EH20G2Z	338	322	280	2,250	2,000		
MVW01 0376 T3300 EH20G2Z	395	376	325	2,500	2,250		
MVW01 0440 T3300 EH20G2Z	463	440	382	3,000	2,600	C	
MVW01 0517 T3300 EH20G2Z	544	517	448	3,500	3,000		
MVW01 0607 T3300 EH20G2Z	639	607	526	3,850	3,600		
MVW01 0713 T3300 EH20G2Z	751	713	618	4,500	4,000		
MVW01 0816 T3300 EH20G2Z	859	816	707	5,000	4,500		
MVW01 0934 T3300 EH20G2Z	984	934	809	6,000	5,000	D	
MVW01 1069 T3300 EH20G2Z	1,126	1,069	926	7,250	6,000		
MVW01 1234 T3300 EH20G2Z	1,300	1,234	1,070	8,000	7,250	E	
MVW01 1425 T3300 EH20G2Z	1,501	1,425	1,235	9,000	8,000		
MVW01 1632 T3300 EH40G2Z	1,718	1,632	1,414	10,000	9,000	2xD	
MVW01 2138 T3300 EH40G2Z	2,252	2,138	1,852	12,500	12,000		
MVW01 2850 T3300 EH40G2Z	3,002	2,850	2,470	17,500	16,000	2xE	
<b>4,160 V</b>							
MVW01 C078 T4160 EH30G2Z	85	78	70	600	550	A0	18
MVW01 C092 T4160 EH30G2Z	101	92	83	700	650		
MVW01 C108 T4160 EH30G2Z	118	108	98	850	750		
MVW01 C128 T4160 EH30G2Z	140	128	115	1,000	900		
MVW01 C151 T4160 EH30G2Z	165	151	135	1,200	1,100		
MVW01 0181 T4160 EH20G2Z	195	181	162	1,500	1,300	A	12
MVW01 0216 T4160 EH20G2Z	233	216	195	1,700	1,600		
MVW01 0260 T4160 EH20G2Z	280	260	235	2,200	1,900		
MVW01 0294 T4160 EH20G2Z	312	294	265	2,500	2,200		
MVW01 0330 T4160 EH20G2Z	350	330	300	2,700	2,500		
MVW01 0405 T4160 EH20G2Z	436	405	365	3,500	3,000	C	
MVW01 0494 T4160 EH20G2Z	532	494	447	4,000	3,700		
MVW01 0561 T4160 EH20G2Z	595	561	506	4,500	4,000		
MVW01 0627 T4160 EH20G2Z	665	627	570	5,000	4,500		
MVW01 0741 T4160 EH20G2Z	798	741	670	6,500	5,500		
MVW01 0835 T4160 EH20G2Z	885	835	757	7,250	6,500	D	
MVW01 0941 T4160 EH20G2Z	998	941	855	7,750	7,250		
MVW01 1087 T4160 EH20G2Z	1,153	1,087	988	8,500	7,750	E	
MVW01 1254 T4160 EH20G2Z	1,330	1,254	1,140	10,000	9,000		
MVW01 1482 T4160 EH40G2Z	1,596	1,482	1,339	12,500	11,000	2xD	
MVW01 1881 T4160 EH40G2Z	1,995	1,881	1,710	16,000	14,000		
MVW01 2508 T4160 EH40G2Z	2,660	2,508	2,280	22,500	20,000	2xE	

Notes: 1) Overload capacity:

- MX = Maximum current/power without overload.
- ND = Normal Duty: maximum current/power with 115% overload for 60 seconds, every 10 minutes.
- HD = Heavy Duty: maximum current/power with 150% overload for 60 seconds, every 10 minutes.

- Motor power is for 4P motor with 0.87 P.F. and 97% efficiency at full load.
- The ratings apply at 40 °C ambient temperature and 1,000 meters above sea level.
- VSD input number pulses can be optimized according to the harmonics requirements.



**MVW01 G2 - Standard VSD - 6,000~6,300 V & 6,600~6,900 V**

Product	Rated current			Motor		Frame size	Rect. pulses	
	Mx	ND	HD	ND	HD			
	A			HP				
<b>6,000~6,300 V</b>								
MVW01 0058 T6300 EH60G2Z	62	58	55	700	600	C1	36	
MVW01 0073 T6300 EH60G2Z	78	73	69	800	750			
MVW01 0091 T6300 EH60G2Z	97	91	86	1,000	900			
MVW01 0114 T6300 EH60G2Z	122	114	108	1,350	1,250			
MVW01 0144 T6300 EH60G2Z	154	144	136	1,750	1,500			
MVW01 0180 T6300 EH60G2Z	181	180	170	2,250	2,000			
MVW01 0212 T6300 EH60G2Z	228	212	198	2,500	2,250	C2		
MVW01 0251 T6300 EH60G2Z	269	251	230	3,000	2,750			
MVW01 0295 T6300 EH60G2Z	317	295	267	3,500	3,000			
MVW01 0348 T6300 EH60G2Z	373	348	310	4,000	3,700			
MVW01 0410 T6300 EH60G2Z	440	410	360	4,750	4,000	C3		
MVW01 0481 T6300 EH60G2Z	516	481	423	5,500	4,500			
MVW01 0565 T6300 EH60G2Z	606	565	496	7,000	6,000			
MVW01 0664 T6300 EH60G2Z	713	664	583	7,500	7,000			
MVW01 0779 T6300 EH60G2Z	836	779	684	9,000	8,000			
<b>6,600~6,900 V</b>								
MVW01 0054 T6900 EH60G2Z	58	54	50	700	600	C1		36
MVW01 0067 T6900 EH60G2Z	72	67	63	800	750			
MVW01 0086 T6900 EH60G2Z	92	86	81	1,000	900			
MVW01 0109 T6900 EH60G2Z	117	109	102	1,350	1,250			
MVW01 0139 T6900 EH60G2Z	149	139	130	1,750	1,750			
MVW01 0177 T6900 EH60G2Z	178	177	165	2,250	2,250			
MVW01 0205 T6900 EH60G2Z	221	205	192	2,750	2,500	C2		
MVW01 0241 T6900 EH60G2Z	260	241	223	3,000	3,000			
MVW01 0283 T6900 EH60G2Z	305	283	259	3,700	3,500			
MVW01 0332 T6900 EH60G2Z	358	332	301	4,000	3,750			
MVW01 0390 T6900 EH60G2Z	420	390	350	4,750	4,500	C3		
MVW01 0458 T6900 EH60G2Z	494	458	411	6,000	5,000			
MVW01 0538 T6900 EH60G2Z	580	538	482	7,250	6,500			
MVW01 0631 T6900 EH60G2Z	680	631	566	8,000	7,500			
MVW01 0740 T6900 EH60G2Z	798	740	665	9,500	8,000			

Notes: 1) Overload capacity:

- MX = Maximum current/power without overload.
- ND = Normal Duty: maximum current/power with 115% overload for 60 seconds, every 10 minutes.
- HD = Heavy Duty: maximum current/power with 150% overload for 60 seconds, every 10 minutes.
  
- Motor power is for reference only and it is based on 4P motor, with 0.87 P.F. and 97% efficiency at full load.
- Ratings apply at 40 °C ambient temperature and up to 1,000 meters above sea level.
- VSD Input rectifier number pulses can be changed according to the harmonics requirement.
- Refer to page 24 for dimensions.



## MVW01 Compact Integrated VSD

MVW01 integral drive system includes all components that are required for a MV VSD standard system design on a small foot print.



### Standard Arrangement and Features

#### Input Switchgear

- Load break switch fuse with vacuum contactor - for up to 6.9 kV, 3 Ph, 60 Hz input
- Mechanical interlocking to prevent access to HV section until switch is in OFF position
- Bottom cable entry or top cable entry

#### Phase Shifting Transformer 18-Pulse as Standard

- With surge arresters on primary HV side
- Impedance matched secondary windings to minimize line side harmonics & reduce losses
- Winding temperature monitoring (Pt-100 in windings) available via 8 channel temperature monitor

#### Assembly Features

- Cable connection arrangement top entry/top exit or bottom entry/bottom exit
- Kirk-key locked enclosure sections for switchgear, transformer and VFD





# MVWCi/MVWMi Integrated VSD

Integrated solution with 24P rectifier generates very low harmonics at Point of Common Coupling (PCC).



### Variations/Features

- 400 HP - 3,000 HP, 4.16 kV, 60 Hz
- Standard NEMA1 (IP21 to IP43) panel assembly for indoor installation
- Kirk-key locked fused disconnect switch with vacuum contactor
- Double tier base frame for passing of power cables/control cables between sections
- VFD transformer can be installed in drive lineup or away from the lineup
- Transformer is available in VPI design for indoor installation or outdoor installation
- Transformer is also available in oil type (mineral oil or FR3) for outdoor installation (pad mount)



Motor		Nominal motor current (Amp)	MVW Ci/Mi	Dimensions H x W x D (inches)	Weight Lbs. (approx.)	Heat loss kW
kW	HP					
300	400	49	MVW Ci 0400	99 x 106 x 40	5,000	8.25
373	500	61	MVW Ci 0500	99 x 106 x 40	5,000	9.30
448	600	74	MVW Ci 0600	99 x 114 x 40	5,000	11.20
522	700	86	MVW Ci 0700	99 x 114 x 40	6,500	13.00
597	800	98	MVW Ci 0800	99 x 114 x 40	6,500	14.90
672	900	110	MVW Ci 0900	99 x 114 x 40	6,500	16.80
746	1,000	123	MVW Ci 1000	99 x 122 x 40	8,000	18.65
933	1,250	153	MVW Ci 1250	99 x 122 x 40	8,000	25.33
1,007	1,350	165	MVW Ci 1350	99 x 122 x 40	8,000	30.12
1,119	1,500	184	MVW Mi 1500	96 x 161 x 40	10,800	30.00
1,306	1,750	215	MVW Mi 1750	96 x 161 x 40	11,500	36.00
1,492	2,000	245	MVW Mi 2000	96 x 161 x 40	11,500	41.00
1,679	2,250	276	MVW Mi 2250	96 x 161 x 40	12,400	46.17
1,865	2,500	307	MVW Mi 2500	96 x 161 x 40	12,400	51.30
2,052	2,750	337	MVW Mi 2750	96 x 176 x 40	14,800	56.43
2,238	3,000	368	MVW Mi 3000	96 x 176 x 40	15,900	61.55

Notes: Motor current is for 4P motor operating at 4.16 kV, 60 Hz, with 0.87 P.F. and 97% efficiency at full load.  
 Overload 115% for 60 seconds (for 1,350 HP, overloads 110%).  
 1 kW = 3,412.14 BTU/hr. for heat loss.  
 Indoor heat loss can be reduced by 50% or more, with transformer installed outdoors. Check with manufacturer for this option.

## Interfaces

### MVW01 Standard Graphical Keypad



Designed to provide full operation, navigation, programming and monitoring of WEG MVW01 in a way that is very similar to WEG LV drives, making its use even easier to those familiar with WEG product line.

WEG standard graphic keypad allows text and graphic visualization modes with monitoring of six variables simultaneously, built-in help, remote mounting and much more.

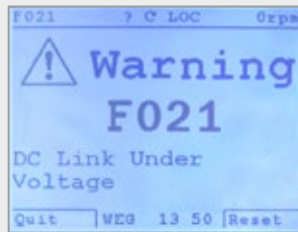

Complete fault descriptions

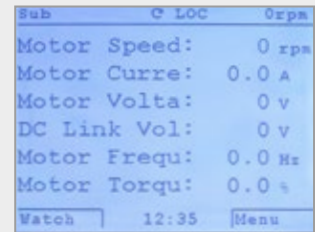

Customization of characters size

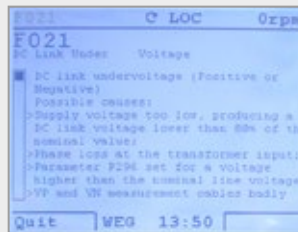

Complete parameters instructions

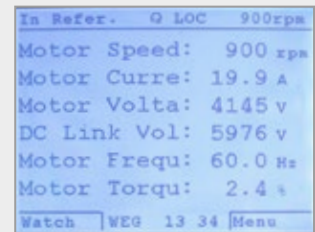

Numerical display

### Touch Screen Keypad

WEG team for SCADA (Supervisory Control and Data Acquisition) is able to add intelligence and agility with customized software for any kind of application.

WEG touch screen keypad gives operators total access to real-time operational data in graphic form allowing them to remotely monitor and control the processes from the VSD front door or a remote location.

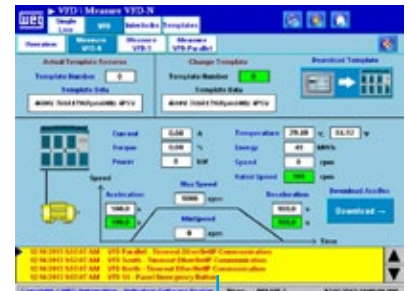
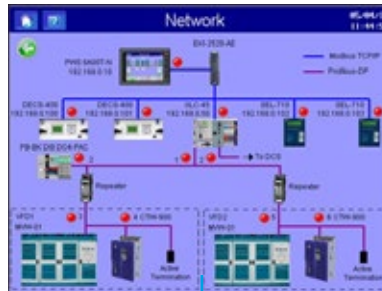





### Superdrive G2

License free software (available at WEG website) for total control and monitoring of WEG MVW01.

- Parameter upload and download
- VSD operation
- VSD monitoring
- On-line and off-line programming

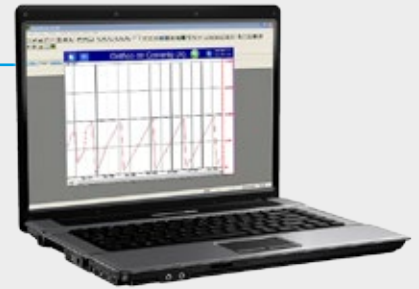

Trace function

## Fieldbus Communication

The MVW01 supports various communications protocols including Modbus-TCP (standard built-in), DeviceNet, Profibus-DP or Profibus-DPV1, Ethernet/IP, CANopen and others, allowing total process monitoring, controlling and complete integration of the system.

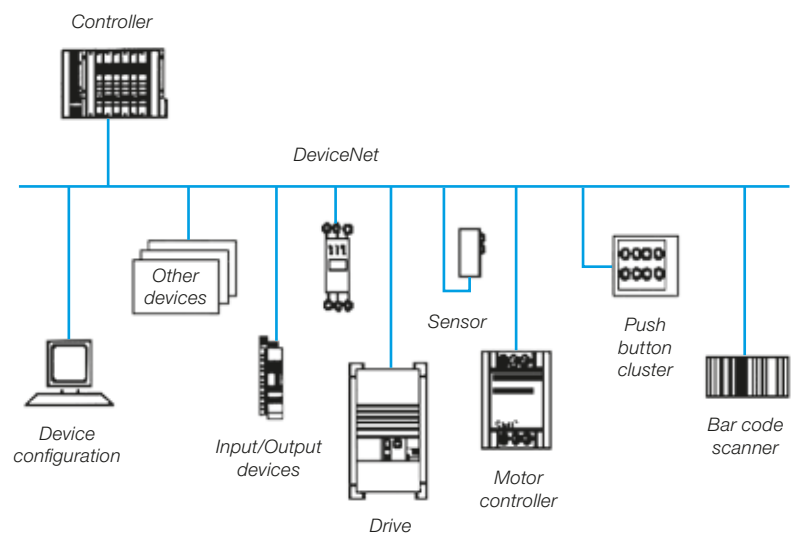

# Innovative Topology Results in an Efficient and Reliable MV Drive System

WEG MVW01 Voltage Source Inverter with 3/5 level NPC is a very simple and reliable topology able to delivery full MV motors control with the minimum number of power semiconductors.

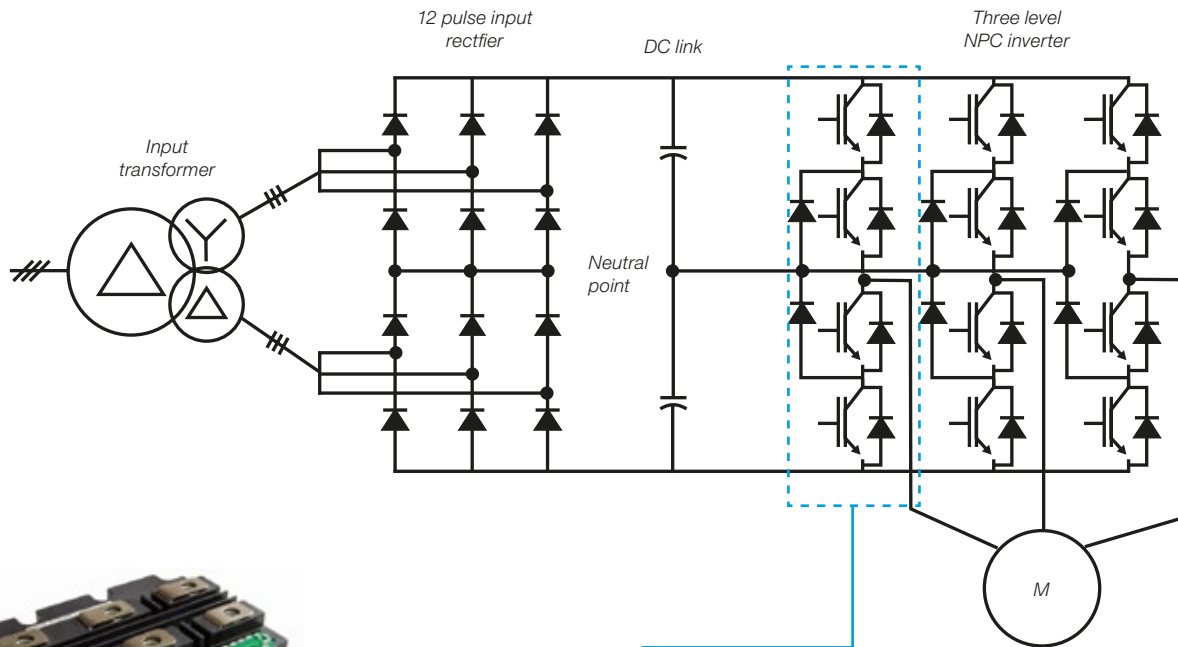

Latest generation of HV 6.5 kV IGBTs

## INVERTER POWER ARM

Optimized sandwich bus-bars to provide a high insulation and short partial discharge levels

Stab power connections that eliminates connecting or disconnecting of power cables



Long life plastic film capacitors for DC link voltage source (same capacitors used by the aero-space industry in satellites)



Draw-out style power modules allowing easy and fast servicing



# Take the Latest Technology Available for One of the Most Technological Product in Industry

Power Semiconductor Devices are the heart of VSDs.

Selection and control of these devices is very important point in performance and reliability of VSD system.

MVW01 G2 VSD employs latest generation HV IGBT devices.

- MOS ~ FET Technology
- Metal Oxide Semiconductor ~ Field Effect Transistor

- HV IGBT 6.5 kV
- Latest Generation
- Reduced Losses
- Dynamic Ruggedness

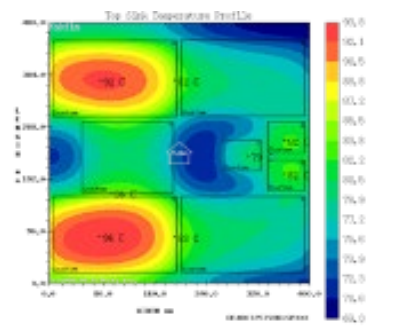
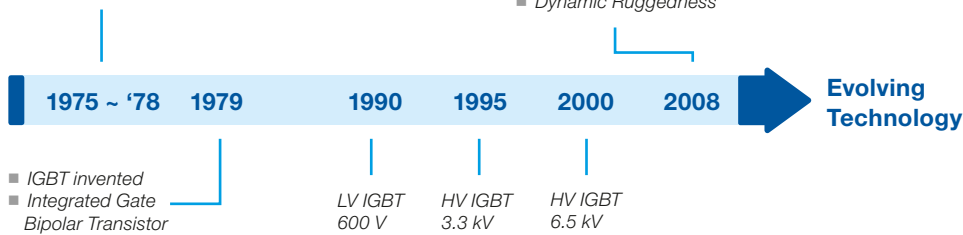

Advanced thermal studies of WEG R&D team together with one of the most important semiconductors manufacturer in the market, allowed WEG to develop the first MV VSD with the latest generation of 6.5 kV IGBTs for general industrial purpose in the world.

## Why Should I Choose HV IGBTs Instead of Other Power Devices?

- Natural strength against short-circuits and over-currents (other devices need extra power components)
- Simplified gate driver circuit (others are much more complex and need electrolytic capacitors)
- Simpler for parallel configuration when compared to other power component devices
- Module with isolated base (easy and fast servicing)
- Positive temperature coefficient for saturation voltages (do not need special snubber circuits)
- IGBTs became standard for LV drives now it is the trend in MV drives with multiple manufacturers



## MVW01 Main Features

**RT**

### Ride Through

The MVW01 VSD is designed and manufactured to take intelligent remedial action to prevent transient supply faults or overload conditions from tripping the VSD.

**FS**

### Flying Start

The MVW01 VSD is capable of restarting and taking control of a motor attached to a spinning load in the forward or reverse direction.

**AR**

### Auto-Restart Capability

The MVW01 VSD is capable of automatically restarting in the event of a momentary loss of power, or a clearing of a drive trip.

**GF**

### Ground Fault Protection

In the event of a ground fault, the MVW01 is capable of annunciating the ground fault condition, safely operating and, by user selection, either trip or continue operation.

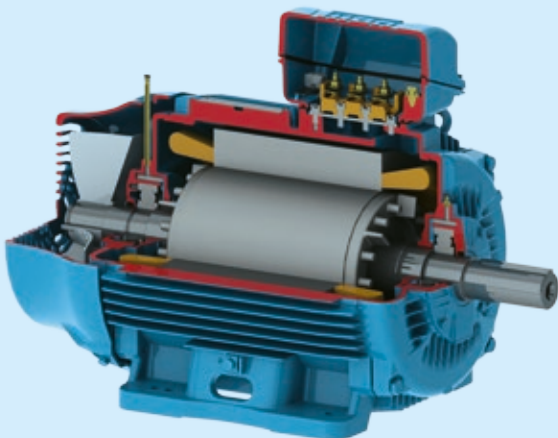

### Optimal Pulse Pattern (OPP™)

Optimum synchronous PWM control minimizes voltage harmonics in the motor circuit and provides the capability to adjust PWM frequency to an optimal use at every speed for every type of application.

### Main Benefits of WEG OPP

- Low commutation losses
- Low motor current THD
- Operation at very low frequency with full torque
- Low noise and vibration on the motor

**OPPTM**

**Output Harmonics with OPP Modulation  
MVW 01**

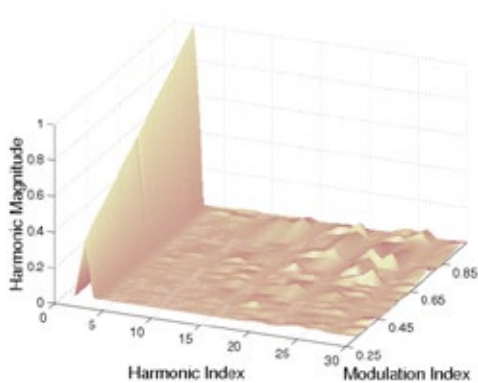

**Output Harmonics with Standard SVM  
Modulation**

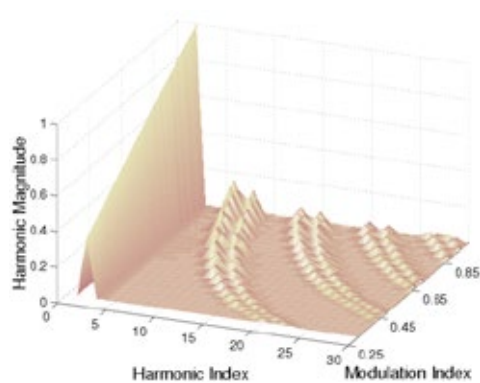





### Main Protections

- Overload protection (1 x t)
- Over/under voltage protection
- Phase loss protection
- Pre-charge circuit fault
- Ground fault
- Optical fiber feedback circuits fault
- CPU Watchdog/EPROM
- External fault
- Speed feedback encoder loss
- Network communication failure
- "Power on" errors
- Output over current
- Input/output short-circuit
- Power supply phase fault
- DC Link checking (power on, short circuit, over/under voltage)
- IGBT fault (optical fiber problem, gate fault, firing fault, etc.) with individual identification

### General Features

- Fault registers: 100 last fault and alarm records with date and time
- Slip compensation
- Adjustable speed and current limits
- Adjustable overload curve
- Copy function of the programming keypad (HMI)
- Flying Start & Ride Through
- Multi-Speed function (up to 8 speeds)
- Skip (critical) speed function
- Alarms and fault messages with date and time
- Motor rated frequency adjustments
- 03 differential analog inputs (10 or 12 bits resolution analog input)
- 04 analog inputs (2x 0...10 V and 2x 4...20 mA)
- 08 fully programmable digital inputs
- 08 fully programmable digital outputs



## MVW System Customized Solutions



WEG customized solutions are based on standard VSD designs and experience gained through testing on a big variety of applications.



- MVW01 AFE/REGENERATIVE/4Q Version
- MVW01 with 2,300 V output
- MVW01 WC - Water Cooled Version
- Field excitation panel for synchronous motors (w/ and w/o bypass) to be connected in the same lineup of the VSD
- Earth-switch (grounding switch)
- Output filters: reactors, dv/dt and sine-wave filter
- Frozen charge software control for SAG mills
- UPS back up control power
- Special painting plan for marine duty application
- IP41/42 enclosure
- Air duct for external venting of exhaust air flow
- Multimotor with sync transfer
- Start and bypass











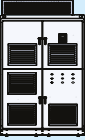

# Specification Table

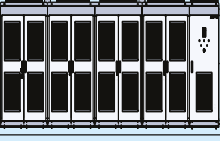
Number	Item	Specification
1	Customer	
2	Application	<input type="checkbox"/> Fan <input type="checkbox"/> Blower <input type="checkbox"/> Pump <input type="checkbox"/> Compressor <input type="checkbox"/> Extruder <input type="checkbox"/> Conveyor <input type="checkbox"/> Agitator <input type="checkbox"/> Other (specify)
3	Load speed/torque	<input type="checkbox"/> VT <input type="checkbox"/> CT <input type="checkbox"/> Constant power <input type="checkbox"/> Other (specify)
		Starting torque ____% Overload ____% s ____Times/hr
4	Regenerative	Y / N
5	Motor data	<input type="checkbox"/> Existing <input type="checkbox"/> New <input type="checkbox"/> SCIM <input type="checkbox"/> SM
		Output _____(HP / kW) Voltage _____V Current _____A
		Frequency _____Hz Number of poles ____ Speed _____rpm
		Efficiency _____ Power factor _____
6	Operating speed range	_____ rpm - _____ rpm
7	Speed sensor	<input type="checkbox"/> Encoder ( _____ ppr) <input type="checkbox"/> Resolver _____
8	Bypass	<input type="checkbox"/> DOL bypass (emergency) <input type="checkbox"/> Synchronous bypass (synch transfer)
9	Power supply	Voltage _____ V Frequency _____ Hz Short Circuit KA (or MVA) _____ kA or MVA
10	VSD transformer	<input type="checkbox"/> Dry (VPI) <input type="checkbox"/> Dry (Cast Coil) <input type="checkbox"/> Oil Filled
11	Control power	Voltage _____ Frequency _____ Capacity _____ kVA
12	Installation (indoors)	Altitude _____ m Ambient temperature _____ °C
13	Special requirements	Please specify any special requirements

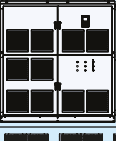

## MVW01 VSD Panel Dimensions

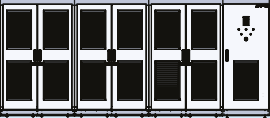
MVW	Size	Height (mm)	Width (mm)	Depth (mm)	Weight (kg)
	A0	2,316	1,000	980	900
	A	2,190	2,400	960	1,560
	B	2,190	2,600	960	1,560
	C	2,190	4,160	960	2,700
	D	2,190	5,920	960	4,500
	E	2,190	7,200	960	5,000
	2D	2,190	5,920 <sup>1)</sup>	1,920 <sup>1)</sup>	9,000
	2E	2,190	7,200 <sup>1)</sup>	1,920 <sup>1)</sup>	10,000
	C1	2,306	1,800	1,200	1,700
	C2	2,223	3,300	1,000	3,100
	C3	2,223	7,480	1,000	6,200

Notes: 1) Back-to-back configuration.  
Dimensions for the standard product.



## Product Code

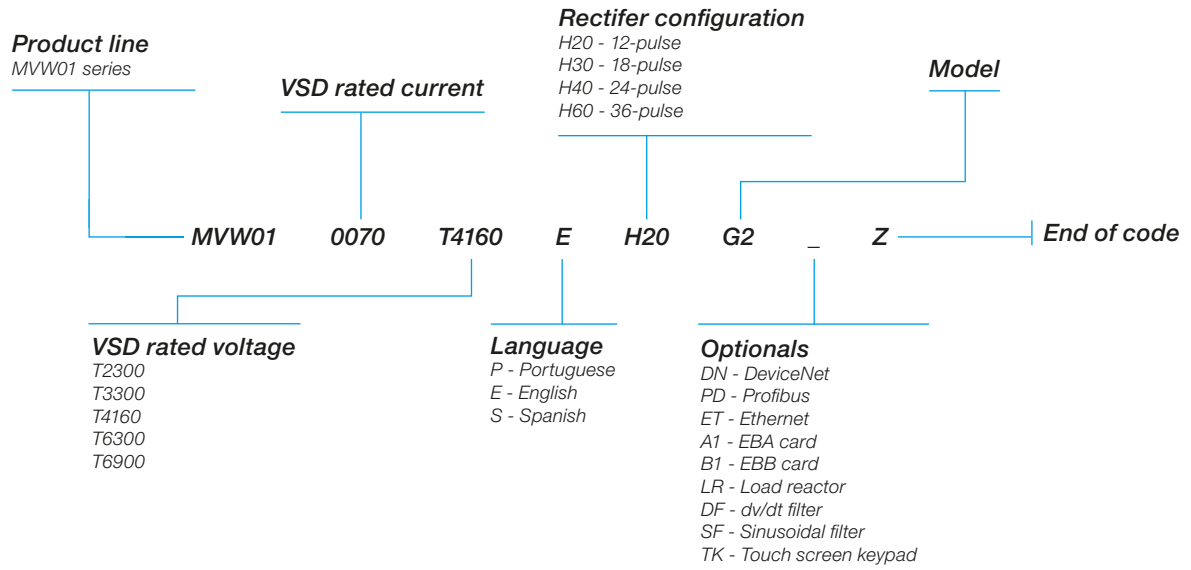

## Dimensions



## General Technical Characteristics

Main power supply	Voltage	Standard up to 13.8 kV <sup>(2)</sup>	
	Frequency	50 or 60 Hz (±3 Hz)	
	Phase unbalance	Less than 3 %	
	Cos φ (power factor)	Greater than 0.97	
	Power transformer	Phase-shifting transformer, dry type or oil type (from 12 to 36 pulse)	
Control power supply	Voltage	Three-phase external supply: 110 to 690 V Internal voltage command: 110, 120 or 220 V via input internal command transformer	
	Frequency	50 or 60 Hz (±3 Hz)	
	Phase unbalance	Less than 3%	
Output	Motor voltage	From 2.3 kV up to 6.9 kV	
	Switching device	High voltage IGBT (HV - IGBT)	
	Frequency range	0...120 Hz	
	Overload capacity	150 % for 60 seconds, every 10 minutes (1.50 x I <sub>rated</sub> - HD)	
		115 % for 60 seconds, every 10 minutes (1.15 x I <sub>rated</sub> - ND)	
Efficiency	Up to 99 % (up to 98 % including isolation transformer)		
Enclosure	Standard	NEMA1/IP41 (IP42 under request)	
Ambient conditions	Temperature	0...40 °C (104 °F) Up to 50 °C (122 °F) with current derating of 2.5% for every 1 °C above 40 °C	
	Humidity	5...90% non-condensing	
	Altitude	0...1,000 m Up to 4,000 m (13,100 ft) with current derating of 10% for every 1,000 m above	
Control	Microprocessor	32 bits	
	Control method	SVM (Space Vector Modulation) and OPP™ (Synchronous Optimal Pulse Patterns)	
	Control types	Scalar (V/F), sensorless vector control and closed loop vector control	
Performance	Speed control	Scalar (V/F)	Regulation: 1% of rated speed with slip compensation Resolution: 1 rpm (keypad reference)
		Sensorless vector control	Speed regulation: 0.5% of rated speed Speed variation range: 1:100
		Closed loop vector control	Regulation: ±0.01% of rated speed with analog input of 14 bits ±0.01% of rated speed with digital reference (keyboard, serial, electronic potentiometer, multispeed) ±0.1% of rated speed with analog input of 10 bits (CC9)
Inputs	Analog	2 programmable differential inputs (10 bits): 0...10 V, 0...20 mA or 4...20 mA	
		1 programmable isolated input (10 bits): 0...10 V, 0...20 mA or 4...20 mA	
		1 programmable isolated input (10 bits): 0...10 V, 0...20 mA or 4...20 mA <sup>(1)</sup>	
		1 programmable bipolar input (14 bits): -10 ... +10 V, 0...20 mA or 4...20 mA <sup>(1)</sup>	
	Digital	8 programmable isolated inputs: 24 V dc 1 programmable isolated input: 24 V dc <sup>(1)</sup> 1 programmable isolated input: 24 V dc (for Motor PTC Thermistor) <sup>(1)</sup>	
Outputs	Analog	2 programmable outputs (11 bits): 0...10 V	
		2 programmable isolated outputs (11 bits): 0...20 mA or 4...20 mA	
		2 programmable bipolar outputs (14 bits): -10...+10 V <sup>(1)</sup>	
		2 programmable isolated outputs (11 bits): 0...20 mA or 4...20 mA <sup>(1)</sup>	
	Relay	5 programmable outputs, form C contacts (NO/NC): 240 V ac, 1 A	
Transistor	2 programmable isolated outputs (open collector): 24 V dc, 50 mA <sup>(1)</sup>		
Communication	Serial interface	RS232 (point-to-point) RS485, isolated, with EBA or EBB expansion boards (multi-point up to 30 drives) <sup>(1)</sup>	
	Fieldbus network	Modbus-RTU, Modbus-TCP, CANopen, Ethernet/IP, Profibus-DP or DeviceNet	
Safety	Protections (fault log of the last 100 faults/alarms with date and time)	DC link overvoltage	Output short circuit
		DC link under voltage	Output ground fault
		VSD and motor overtemperature	External fault
		Output overcurrent	Self-diagnosis fault and programming error
		Motor overload (I x t)	Serial communication fault
		Dynamic braking resistor overload	Power supply phase loss
		CPU/EPROM error (Watchdog)	Keypad connection fault
Finishing	Color	Light blue (doors)	
		Dark blue (base, roof and shutter)	



Conformities/standards	Electromagnetic compatibility	EMC directive 89/336/EEC-Industrial Environment CEI standard - IEC61800-3 (EMC - Emission and Immunity)	
	CEI - IEC61800	Adjustable speed electrical power drive system	
		Part 4 - general requirements	
		Part 5 - safety requirements	
Underwriters laboratories	UL 347, UL 347A		
European commission	CE		
Keypad	Commands	Start/stop, general functions programming	
		Increase/decrease speed	
		JOG, FWD/REV and local/remote	
	Monitoring	Speed reference (rpm)	Output current (A)
		Motor speed (rpm)	Output voltage (V)
		Speed proportional value (Ex: ft/min)	Drive status
		Output frequency (Hz)	Status of digital inputs
		DC link voltage (V)	Status of digital outputs
		Motor torque (%)	Status of relay outputs
		Output power (kW)	Analog inputs value
Motor running hours (h)	100 last faults with date and time		
VSD enabled hours (h)	Fault/alert messages		
Control features	Standard	Keypad with LCD displays	
		Password to protect drive programming	
		LCD display language selection: English, Spanish, French, Deutsch and Portuguese	
		Fault auto-diagnosis and auto-reset	
		Parameters reset to factory or user default	
		Specific unit indication (Ex: l/s, t/h, %, etc.)	
		Slip compensation (V/Hz mode)	
		Manual and automatic torque boost - I x R (V/Hz mode)	
		Adjustable V/Hz curve (V/Hz mode)	
		Minimum and maximum set-points for speed, current, and DC-link voltage	
		Adjustable motor overload protection	
		Adjustable digital gain and offset for the analog inputs	
		Adjustable digital gain for the analog outputs	
		JOG +/-JOG - function (momentary speed increase/decrease)	
		Copy-paste/backup function (drive ↔ keypad)	
		Comparison functions for the digital outputs: N <sup>1)</sup> > Nx; N > Nx; N < Nx ; N = 0; N = N <sup>1)</sup> ; Is > Ix ; Is < Ix; T > Tx and T < Tx Where: N = Motor speed; N <sup>1)</sup> = Speed reference; Is = Output current and T = Motor torque	
		Linear and "S type" ramps and double ramp	
		Independent acceleration and deceleration ramps	
		Multi-speed function (up to 8 preset speeds)	
		Special indicators (hour meter and wattmeter)	
		Overlapped PID regulator (for automatic level, flow, pressure, and weight control)	
		Direction of rotation selection (FWD/REV)	
		Local/remote operation selection	
Flying start function (restart with a spinning load)			
Critical speed avoidance (skip up to 3 speeds)			
Ride-through function (operation during momentary power loss)			
Interface	Accessories	NEMA4 remote keypad (LCD display)	
		Remote keypad cable (3.3, 6.6, 10, 16, 25 and 35 ft)	
		Blank keypad for local installation	
		Blank keypad for remote installation	
		Remote keypad frame kit	
		Expansion boards with special functions	
		Communication boards	
		SUPERDRIVE kit with RS232 serial interface communication (drive ↔ PC)	
		PLC2 integrated for PLC functions and logics	
Touch screen HMI with process information			

Notes: 1) Expansion board.  
2) Other configurations, consult WEG.

# Environmental Policy

Guarantee **the lowest environmental impact** of **our products** and manufacturing processes by:



Being in compliance with the applicable **environmental legislation**



Improving continuously by establishing **environmental goals** and **targets**



Acting preventively with the aim of **protecting the environment**



**Ecoefficient** processes and products, saving **natural resources**

## WEG Green

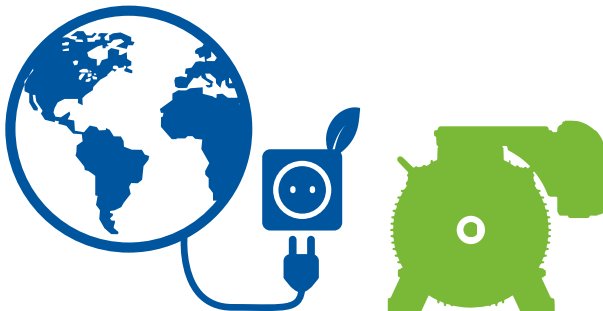

### Certifications

ISO 50001:2011  
ISO 14001:2014  
ISO 9001:2008



# Efficiency for us is to create sustainable solutions!

As global market keeps growing every day, as energy demands grow together. Be part of sustainable economy is our responsibility, this way WEG supplies smart and efficient solutions.

Medium voltage loads are commonly part of the largest consumers inside industries, the use of medium voltage VSDs for these applications most of the times can dramatically decrease the use of energy and power consumption, consequently reducing CO<sub>2</sub> and other emissions.







# Global presence is essential, as much as understanding your needs.

## Global Presence

With more than 30,000 employees worldwide, WEG is one of the largest electric motors, electronic equipments and systems manufacturers. We are constantly expanding our portfolio of products and services with expertise and market knowledge. We create integrated and customized solutions ranging from innovative products to complete after-sales service.

WEG's know-how guarantees our **medium voltage variable speed drive MVW01** is the right choice for your application and business, assuring safety, efficiency and reliability.



**Availability** is to have a global support network



**Partnership** is to create solutions that suits your needs



**Competitive edge** is to unite technology and innovation





High performance and reliable products to improve your production process.

*MV Switchgears*



*Soft-Starters*



*Phase Shifting Transformer*



Excellence is to provide a whole solution in industrial automation that improves our customers productivity.

Visit: [www.weg.net](http://www.weg.net)

[youtube.com/wegvideos](https://youtube.com/wegvideos)

# WEG Worldwide Operations

## ARGENTINA

San Francisco - Cordoba  
Phone: +54 3564 421484  
[info-ar@weg.net](mailto:info-ar@weg.net)

Cordoba - Cordoba  
Phone: +54 351 4641366  
[weg-morbe@weg.com.ar](mailto:weg-morbe@weg.com.ar)

Buenos Aires  
Phone: +54 11 42998000  
[ventas@pulverlux.com.ar](mailto:ventas@pulverlux.com.ar)

## AUSTRALIA

Scoresby - Victoria  
Phone: +61 3 97654600  
[info-au@weg.net](mailto:info-au@weg.net)

## AUSTRIA

Markt Piesting - Wiener  
Neustadt-Land  
Phone: +43 2633 4040  
[watt@wattdrive.com](mailto:watt@wattdrive.com)

## BELGIUM

Nivelles - Belgium  
Phone: +32 67 888420  
[info-be@weg.net](mailto:info-be@weg.net)

## BRAZIL

Jaraguá do Sul - Santa Catarina  
Phone: +55 47 32764000  
[info-br@weg.net](mailto:info-br@weg.net)

## CHILE

La Reina - Santiago  
Phone: +56 2 27848900  
[info-cl@weg.net](mailto:info-cl@weg.net)

## CHINA

Nantong - Jiangsu  
Phone: +86 513 85989333  
[info-cn@weg.net](mailto:info-cn@weg.net)

Changzhou - Jiangsu  
Phone: +86 519 88067692  
[info-cn@weg.net](mailto:info-cn@weg.net)

## COLOMBIA

San Cayetano - Bogota  
Phone: +57 1 4160166  
[info-co@weg.net](mailto:info-co@weg.net)

## ECUADOR

El Batan - Quito  
Phone: +593 2 5144339  
[ceccato@weg.net](mailto:ceccato@weg.net)

## FRANCE

Saint-Quentin-Fallavier - Isère  
Phone: +33 4 74991135  
[info-fr@weg.net](mailto:info-fr@weg.net)

## GERMANY

Türnich - Kerpen  
Phone: +49 2237 92910  
[info-de@weg.net](mailto:info-de@weg.net)

Balingen - Baden-Württemberg  
Phone: +49 7433 90410  
[info@weg-antriebe.de](mailto:info@weg-antriebe.de)

Homburg (Efze) - Hesse  
Phone: +49 5681 99520  
[info@akh-antriebstechnik.de](mailto:info@akh-antriebstechnik.de)

## GHANA

Accra  
Phone: +233 30 2766490  
[info@zestghana.com.gh](mailto:info@zestghana.com.gh)

## INDIA

Bangalore - Karnataka  
Phone: +91 80 41282007  
[info-in@weg.net](mailto:info-in@weg.net)

Hosur - Tamil Nadu  
Phone: +91 4344 301577  
[info-in@weg.net](mailto:info-in@weg.net)

## ITALY

Cinisello Balsamo - Milano  
Phone: +39 2 61293535  
[info-it@weg.net](mailto:info-it@weg.net)

## JAPAN

Yokohama - Kanagawa  
Phone: +81 45 5503030  
[info-jp@weg.net](mailto:info-jp@weg.net)

## MALAYSIA

Shah Alam - Selangor  
Phone: +60 3 78591626  
[info@wattdrive.com.my](mailto:info@wattdrive.com.my)

## MEXICO

Huehuetoca - Mexico  
Phone: +52 55 53214275  
[info-mx@weg.net](mailto:info-mx@weg.net)

Tizayuca - Hidalgo  
Phone: +52 77 97963790

## NETHERLANDS

Oldenzaal - Overijssel  
Phone: +31 541 571080  
[info-nl@weg.net](mailto:info-nl@weg.net)

## PERU

La Victoria - Lima  
Phone: +51 1 2097600  
[info-pe@weg.net](mailto:info-pe@weg.net)

## PORTUGAL

Maia - Porto  
Phone: +351 22 9477700  
[info-pt@weg.net](mailto:info-pt@weg.net)

## RUSSIA and CIS

Saint Petersburg  
Phone: +7 812 363 2172  
[sales-wes@weg.net](mailto:sales-wes@weg.net)

## SOUTH AFRICA

Johannesburg  
Phone: +27 11 7236000  
[info@zest.co.za](mailto:info@zest.co.za)

## SPAIN

Coslada - Madrid  
Phone: +34 91 6553008  
[wegiberia@wegiberia.es](mailto:wegiberia@wegiberia.es)

## SINGAPORE

Singapore  
Phone: +65 68589081  
[info-sg@weg.net](mailto:info-sg@weg.net)

Singapore  
Phone: +65 68622220  
[watteuro@watteuro.com.sg](mailto:watteuro@watteuro.com.sg)

## SCANDINAVIA

Mölnlycke - Sweden  
Phone: +46 31 888000  
[info-se@weg.net](mailto:info-se@weg.net)

## UK

Redditch - Worcestershire  
Phone: +44 1527 513800  
[info-uk@weg.net](mailto:info-uk@weg.net)

## UNITED ARAB EMIRATES

Jebel Ali - Dubai  
Phone: +971 4 8130800  
[info-ae@weg.net](mailto:info-ae@weg.net)

## USA

Duluth - Georgia  
Phone: +1 678 2492000  
[info-us@weg.net](mailto:info-us@weg.net)

Minneapolis - Minnesota  
Phone: +1 612 3788000

## VENEZUELA

Valencia - Carabobo  
Phone: +58 241 8210582  
[info-ve@weg.net](mailto:info-ve@weg.net)

For those countries where there is not a WEG own operation, find our local distributor at [www.weg.net](http://www.weg.net).



WEG Group - Automation Business Unit  
Jaraguá do Sul - SC - Brazil  
Phone: +55 47 3276 4000  
[automacao@weg.net](mailto:automacao@weg.net)  
[www.weg.net](http://www.weg.net)

